



ALUMINIO PANAMERICANA

CATÁLOGO TÉCNICO



Líneas de Contacto

 11-5023-7969

 Aluminio Panamericana

 Aluminio.Panamericana.ok

 4756+5834 / 4762-3487 / 4554-2838

 ventas@aluminiopanamericana.com.ar

 Colectora Este 1717, Don Torcuato

INDICE LINEAS

● LINEA CLASICA	5	● LINEA MASS	75
● LINEA PLACARD	22	● PERFILES COMPLEMENT.	78
● LINEA ACTUAL	24	● LINEA PLACARD ESTRUCT.	83
● LINEA MASS R60	67		

INDICE

LINEA CLASICA

ABERTURAS CORREDIZAS

MARCOS	5
HOJAS TRAVESAÑOS	6
HOJAS PARANTE LATERAL	6
HOJAS PARANTE CENTRAL	7
TAPAJUNTAS	7

MOSQUITEROS

MOSQUITEROS CORREDIZOS	8
MOSQUITEROS DE ABRIR	8

PAÑO FIJO

PAÑO FIJO	9
-----------	---

PAÑO FIJO - VENTILUZ - BANDEROLA

PAÑO FIJO	10
VENTILUZ - BANDEROLA	10

PUERTAS

PUERTAS HOJAS 34 mm	11
PUERTAS HOJAS 45 mm	12
PUERTAS HOJAS 36 mm con burlete	12
PUERTAS HOJAS 36 mm con contrav.	13
PUERTAS HOJAS 25 mm	14
POSTIGON Y TABLILLAS DE 25 mm	14

CORTINAS ENROLLAR - TABIQUES

CORTINAS ENROLLAR	16
-------------------	----

MAMPARA DE BAÑO - PARASOLES - TECHO

MAMPARA DE BAÑO	17
PARASOLES Y TECHO	17

LINEA CLASICA

ACOPLES Y ESCUADRAS

ACOPLES Y ESCUADRAS VITRINA	19
ADAPTADORES Y VIDRIOS REPARTIDOS	20

PREMARCOS

PREMARCOS	21
VITRINA	21

LINEA PLACARD

PLACARD	22
---------	----

LINEA MASS - VENTANA DE ABRIR	23
-------------------------------	----

LINEA ACTUAL

CORREDIZAS CORTE 90°

MARCOS - GUIA SIMPLE	24
HOJAS PARANTES	25
ZÓCALOS	26
TRAVESAÑOS Y TAPAJUNTAS	27

CORREDIZAS CORTE 45°

CORREDIZAS CORTE 45 - HOJA Y MARCOS	28
-------------------------------------	----

CORREDIZAS

GUIAS CORTINA Y PREMARCO	29
MOSQUITEROS	30

PAÑO FIJO

PAÑO FIJO Y TRAVESAÑOS, MARCOS DE PUERTA, CONTRAVIDRIOS, ENCUENTRO CENTRAL DE ABRIR.	31
--	----

VENTANA ABRIR FRANCESA / OB

HOJA RECTA Y CURVA / CAMARA COMPENSADORA	33
HOJA CURVA Y RECTA / DOBLE CONTACTO	34

VENTANA VENTILUZ

VENTILUZ RECTO	35
----------------	----

VENTANA BANDEROLA

BANDEROLA / HOJA RECTA	36
BANDEROLA / HOJA CURVA	37

VENTANA VENTILUZ

VENTILUZ / HOJA CURVA	38
-----------------------	----

VENTANA DE ABRIR

HOJAS CON CONTRAVIDRIO INCORPORADO	38
------------------------------------	----

LINEA ACTUAL

VENTANA DESPLAZABLE

DESPLAZABLE O PROYECTANTE (CON TIJERAS INOX.)	39
--	----

PUERTAS DE ABRIR

PUERTAS DOBLE CONTACTO	40
------------------------	----

PUERTAS DE ABRIR DOBLE CONTACTO

HOJA CON CONTRAVIDRIO INCORPORADO	42
-----------------------------------	----

ACOPLES	43
---------	----

BARANDA BALCON

BARANDA PANORAMA	44
PASAMANOS	45

FRENTE INTEGRAL

FRENTE INTEGRAL	46
-----------------	----

PIEL DE VIDRIO

PIEL DE VIDRIO	49
----------------	----

LINEA MASS R60 53

LINEA RPT R60 59

LINEA Mass R60 67

LINEA Mass R60 Osciloparalela 71

VENTANA DE ABRIR

HOJA OCULTA	75
-------------	----

PERFILES COMPLEMENTARIOS 95

PAÑO FIJO

CONTRAVIDRIOS	80
CONTRAVIDRIO - DISTANCIA EN mm.	82

ESTRUCTURALES

TUBO REDONDO	85
TUBO CUADRADO	86
TUBO RECTANGULAR	87
PERFILES "L"	88
PERFILES EN T	89
PERFILES EN U	90
PLANCHUELA	91
ANGULOS	92
ANGULOS ALAS DESIGUALES	103

ABERTURAS CORREDIZAS

MARCOS

MT- 0901

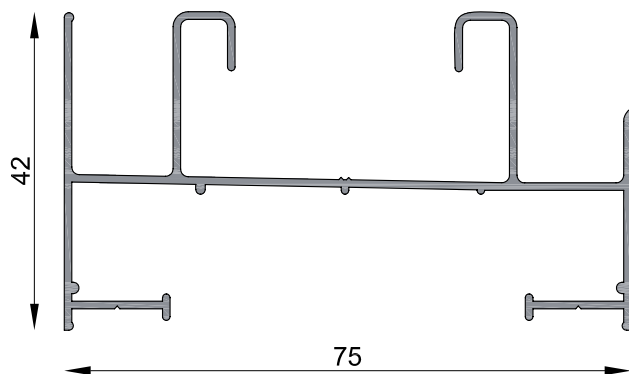

Marco Liviano Corrediza
Peso estimado: 0.743 Kg/m
Largo STD: 6150 mm

MT- 0690

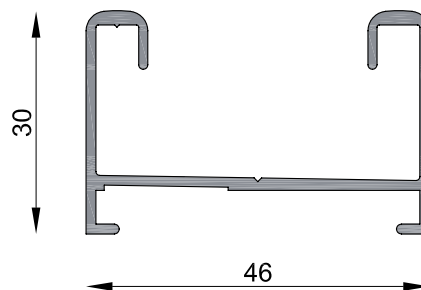

Marco para hojas corredizas
Peso estimado: 0.486 Kg/m
Largo STD: 6150 mm

MT- 0017

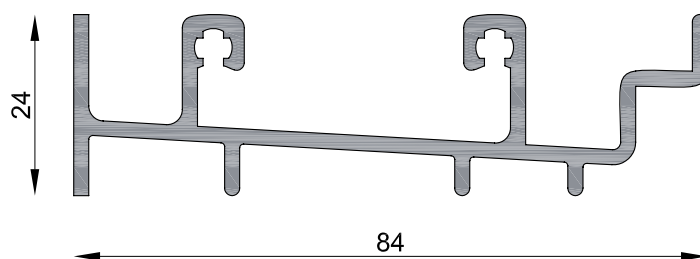

Umbral de puerta corrediza
Peso estimado: 1.048 Kg/m
Largo STD: 6030 mm

MT- 0691

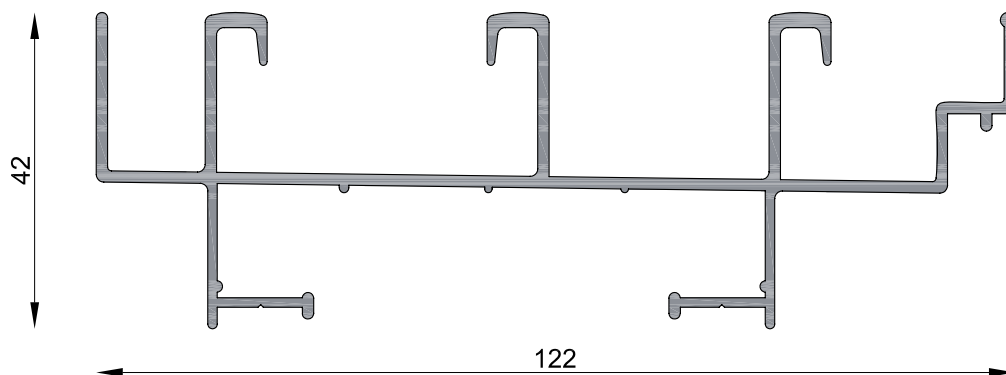

Marco de tres guías
Peso estimado: 1.323 Kg/m
Largo STD: 6150 mm

ABERTURAS CORREDIZAS

HOJAS "TRAVESAÑOS"

MT- 0944

MT- 0902

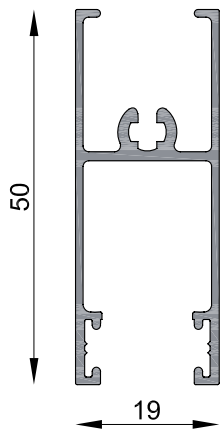

Travesaño hoja corrediza
Peso estimado: 0.432 Kg/m
Largo STD: 6030 mm

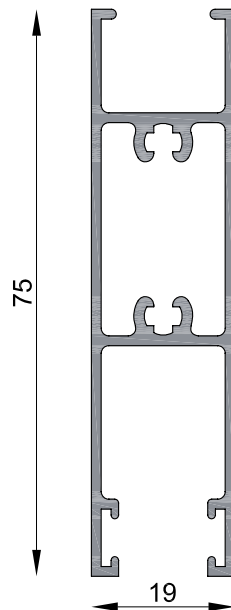

Travesaño reforzado
Peso estimado: 0.810 Kg/m
Largo STD: 6030 mm

MT- 2428

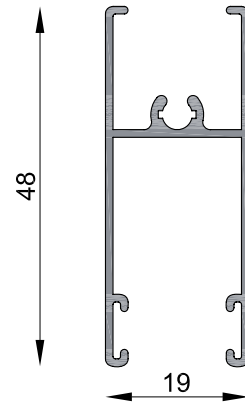

Travesaño hoja corrediza
Peso estimado: 0.381 Kg/m
Largo STD: 6030 mm

HOJAS PARANTE LATERAL

MT- 0903

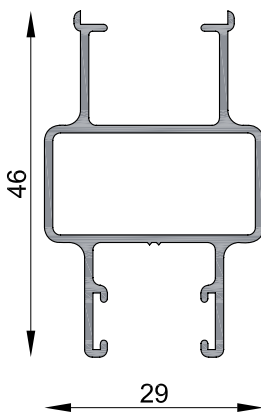

Parante lateral hoja corrediza
Peso estimado: 0.462 Kg/m
Largo STD: 6150 mm

MT- 0053

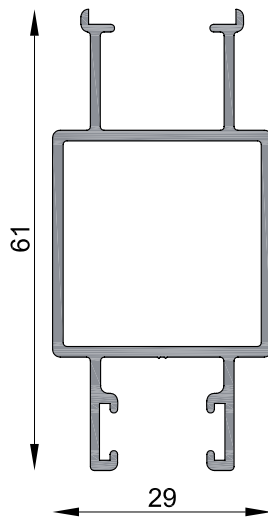

Parante lateral hoja corrediza
Peso estimado: 0.694 Kg/m
Largo STD: 6150 mm

MT- 0853

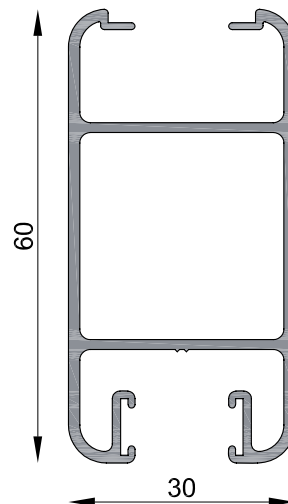

Parante lateral reforzado
Peso estimado: 0.829 Kg/m
Largo STD: 6150 mm

MT- 2963

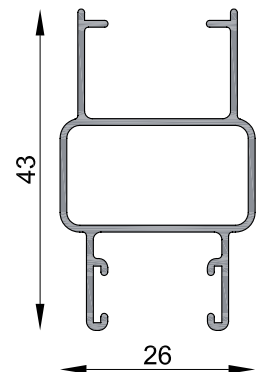

Parante lateral hoja corrediza
Peso estimado: 0.359 Kg/m
Largo STD: 6150 mm

ABERTURAS CORREDIZAS

HOJAS PARANTE CENTRAL

MT- 0054

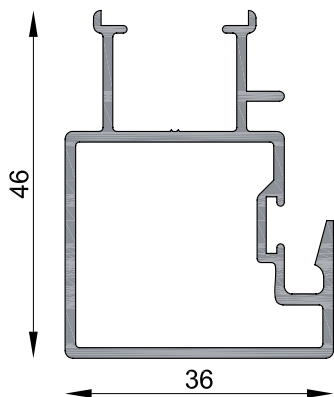

Parante central
Peso estimado: 0.670 Kg/m
Largo STD: 6150 mm

MT- 0904

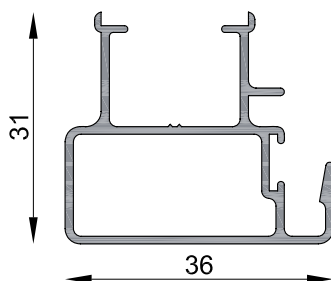

Parante central
Peso estimado: 0.410 Kg/m
Largo STD: 6150 mm

MT- 0854

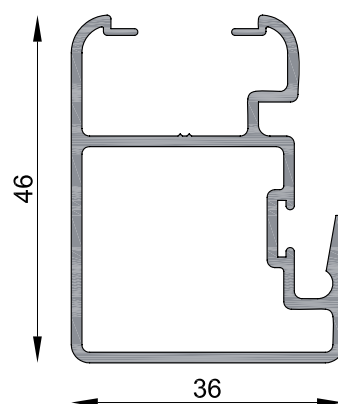

Parante central reforzado moderno
Peso estimado: 0.726 Kg/m
Largo STD: 6150 mm

MT- 2964

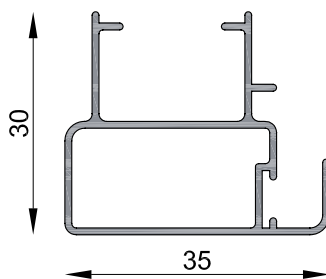

Parante central
Peso estimado: 0.338 Kg/m
Largo STD: 6150 mm

TAPAJUNTAS

MT- 0046

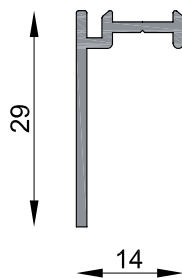

Contramarco
Peso est.: 0.181 Kg/m
Largo STD: 6030 mm

MT- 0829

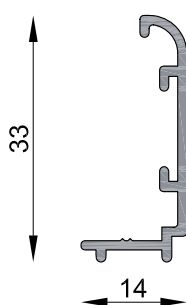

Contramarco
Peso est.: 0.197 Kg/m
Largo STD: 6030 mm

MT- 0906

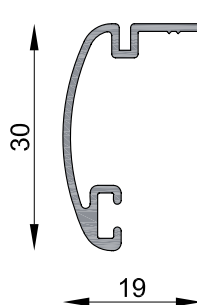

Contramarco
Peso est.: 0.186 Kg/m
Largo STD: 6030 mm

AF-6031

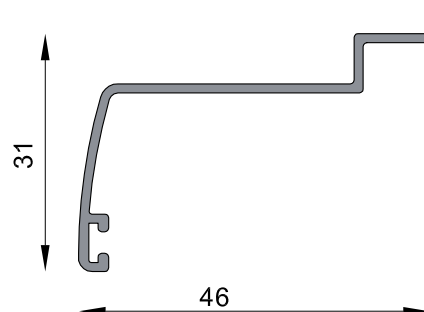

Contramarco desplazado interior
Peso est.: 0.265 Kg/m
Largo STD: 6030 mm

MOSQUITEROS

MOSQUITEROS CORREDIZOS

MT- 0905

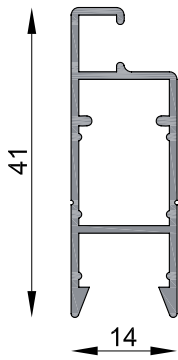

Hoja mosquitero
Peso estimado: 0.313 Kg/m
Largo STD: 6030 mm

MT- 1110

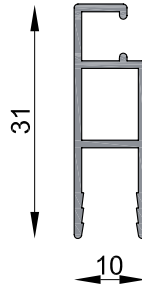

Hoja mosquitero
Peso estimado: 0.211 Kg/m
Largo STD: 6030 mm

MT- 0990

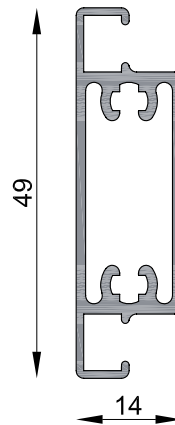

Travesaño de mosquitero
Peso estimado: 0.486 Kg/m
Largo STD: 6030 mm

MT- 1573

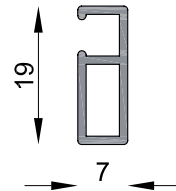

Hoja mosquitero fijo
Peso estimado: 0.135 Kg/m
Largo STD: 6030 mm

MOSQUITEROS DE ABRIR

MT- 0599

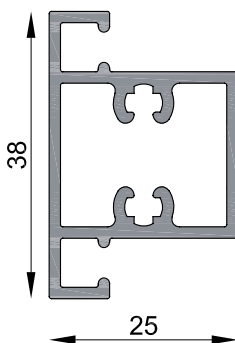

Travesaño mosquitero
Peso estimado: 0.605 Kg/m
Largo STD: 6030 mm

MT- 0822

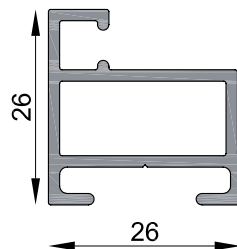

Batiente mosquitero
Peso estimado: 0.429 Kg/m
Largo STD: 6030 mm

MT- 0967

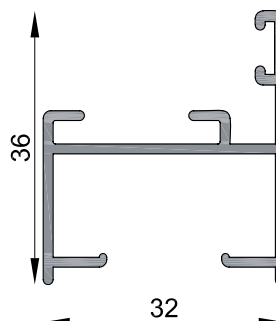

Marco simple de 31mm
Peso estimado: 0.429 Kg/m
Largo STD: 6150 mm

MT- 6151

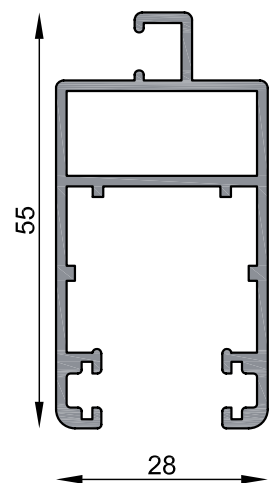

Mosquitero reforzado
Peso estimado: 0.732 Kg/m
Largo STD: 6150 mm

PAÑO FIJO

PAÑO FIJO

MT- 0711

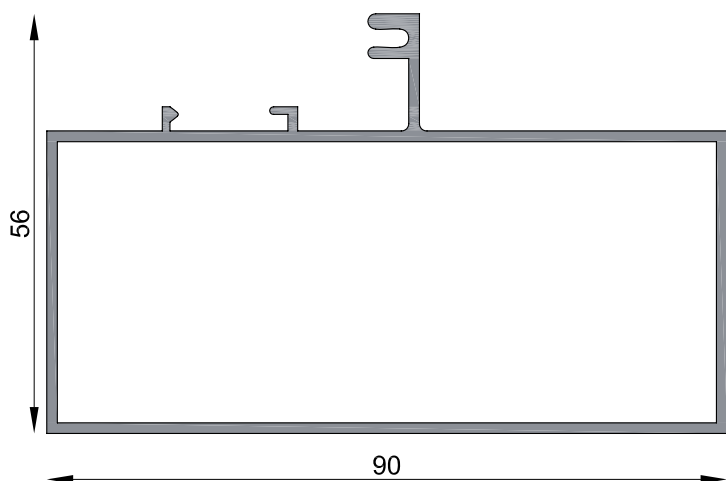

Paño fijo tubular (90 x 40 mm)
Peso estimado: 1.102 Kg/m
Largo STD: 6150 mm

MT- 0907

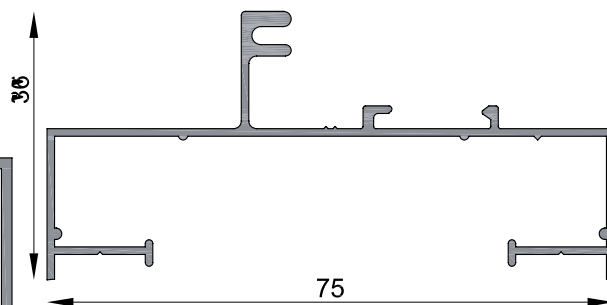

Marco Perimetral Paño Fijo
Peso estimado: 0.524 Kg/m
Largo STD: 6150 mm

MT- 0994

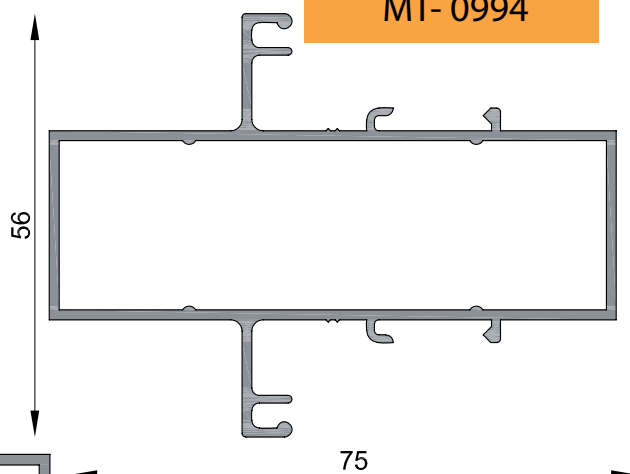

Travesaño paño fijo
Peso estimado: 0.929 Kg/m
Largo STD: 6130 mm

MT- 0700

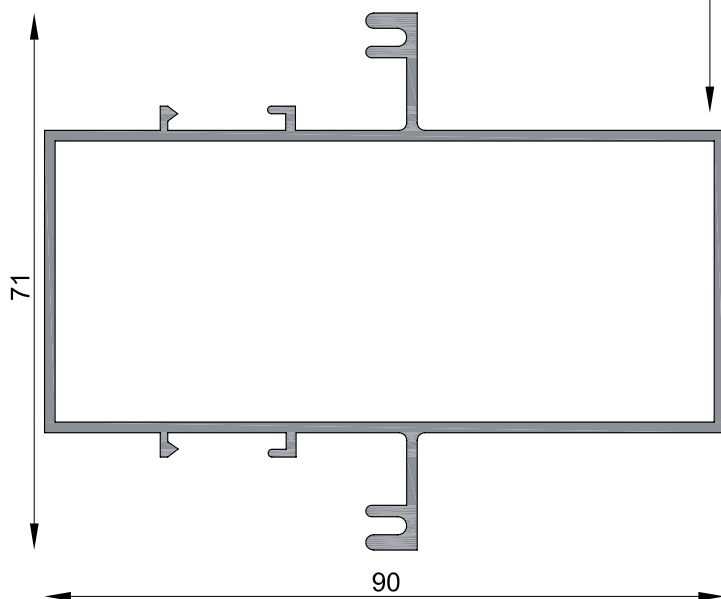

Travesaño tubular paño fijo
Peso estimado: 1.242 Kg/m
Largo STD: 6030 mm

MT- 0925

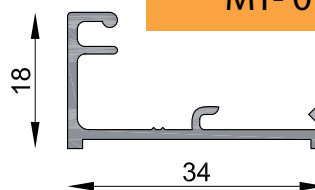

Porta contravidrio simple
Peso estimado: 0.251 Kg/m
Largo STD: 6030 mm

PAÑO FIJO - VENTILUZ - BANDEROLA

PAÑO FIJO

MT- 0078

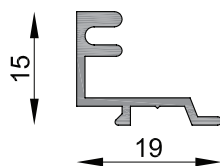

Contravidrio
Peso estimado: 0.151 Kg/m
Largo STD: 6030 mm

MT- 0973

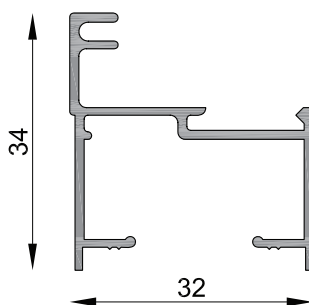

Marco paño fijo
Peso estimado: 0.359 Kg/m
Largo STD: 6150 mm

MT- 0908

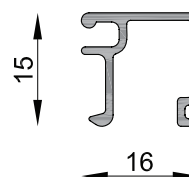

Contravidrio universal
Peso estimado: 0.151 Kg/m
Largo STD: 6030 mm

MT- 0975

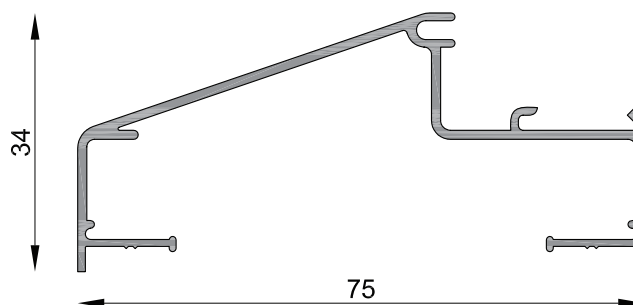

Marco paño fijo inclinado
Peso estimado: 0.532 Kg/m
Largo STD: 6150 mm

VENTILUZ - BANDEROLA

MT- 0914

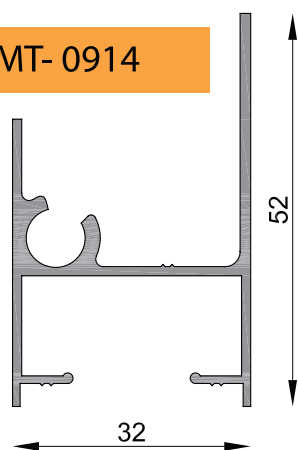

Marco ventana proyectante o banderola
Peso estimado: 0.524 Kg/m
Largo STD: 6150 mm

MT- 0916

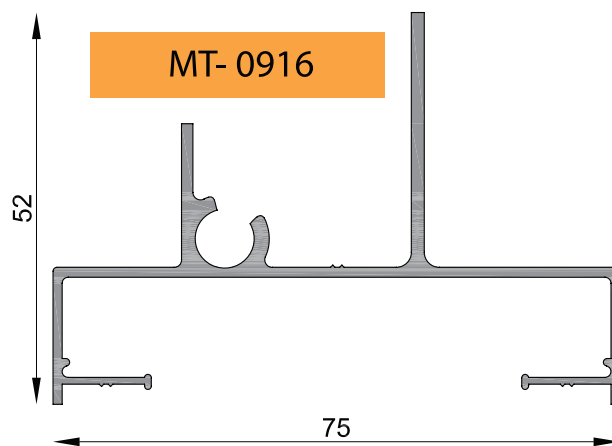

Marco ventana proyectante o banderola
Peso estimado: 0.716 Kg/m
Largo STD: 6150 mm

VENTILUZ - BANDEROLA

VENTILUZ - BANDEROLA - HOJAS

MT- 0915

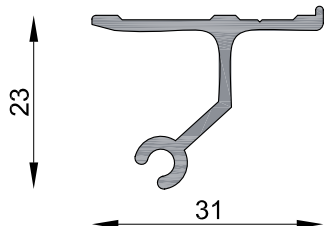

Bisagra vent. proyectante o banderola
Peso estimado: 0.281 Kg/m
Largo STD: 6030 mm

MT- 0917

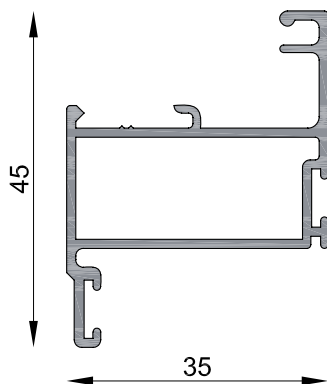

Hoja inferior ventana banderola
Peso estimado: 0.513 Kg/m
Largo STD: 6030 mm

MT- 0918

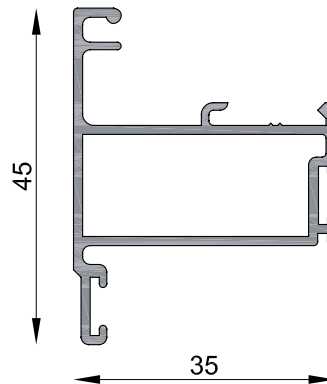

Hoja superior ventana proyectante
Peso estimado: 0.513 Kg/m
Largo STD: 6030 mm

PUERTAS

PUERTAS - HOJA 34 mm

MT- 0510

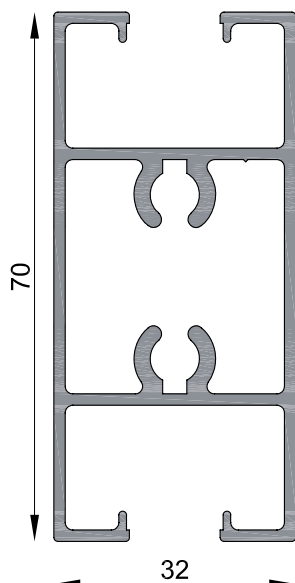

Travesaño puerta rebatir
Peso estimado: 1.207 Kg/m
Largo STD: 6030 mm

MT- 0511

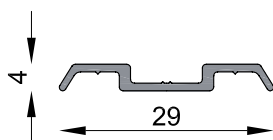

Tapacanto puerta de rebatir
Peso estimado: 0.103 Kg/m
Largo STD: 6030 mm

MT- 0507

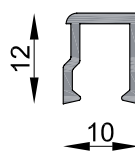

Contravidrio
Peso estimado: 0.111 Kg/m
Largo STD: 6030 mm

MT- 0509

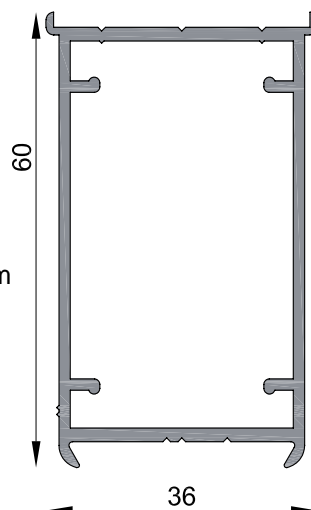

Hoja puerta de rebatir
Peso estimado: 0.840 Kg/m
Largo STD: 6030 mm

MT- 0524

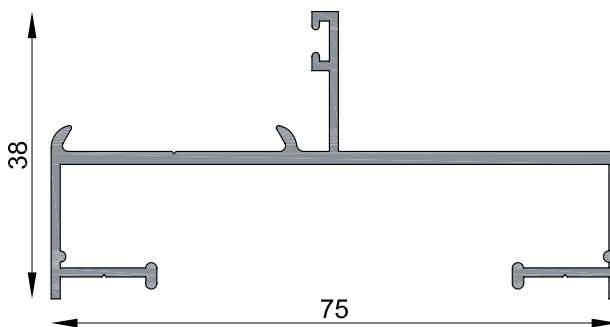

Marco puerta de rebatir bisagra encolizada
Peso estimado: 0.672 Kg/m
Largo STD: 6150 mm

PUERTAS

PUERTAS - HOJA 45 mm

MT- 0815

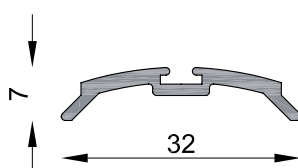

Tapacanto vaivén
 Peso estimado: 0.189 Kg/m
 Largo STD: 6030 mm

PUERTAS - HOJA 36 mm con Burlete

MT- 0824

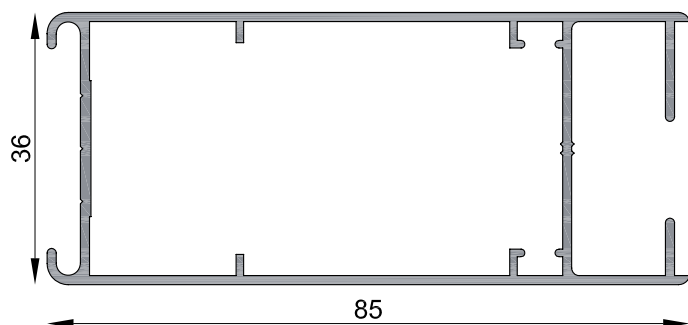

Parante puerta
 Peso estimado: 0.907 Kg/m
 Largo STD: 6150 mm

MT- 0840

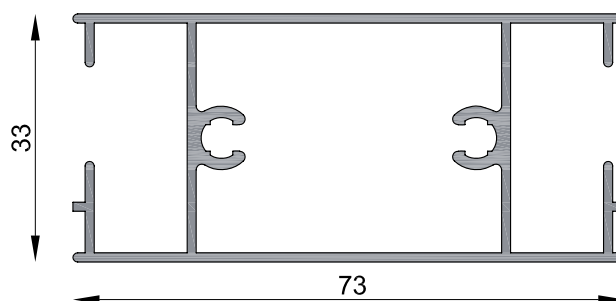

Travesaño puerta
 Peso estimado: 0.926 Kg/m
 Largo STD: 6030 mm

PUERTAS - HOJA 36 mm con Burlete

MT- 0839

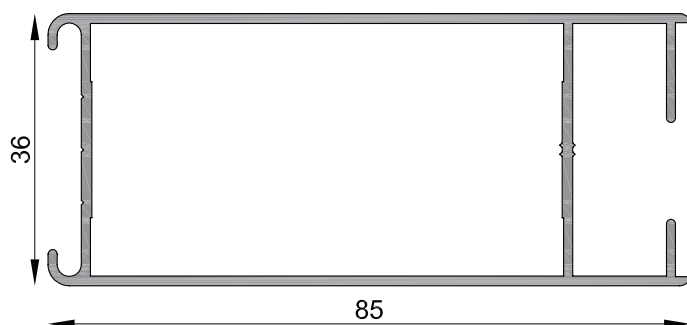

Parante puerta 36 mm
Peso estimado: 0.913 Kg/m
Largo STD: 6150 mm

MT- 0934

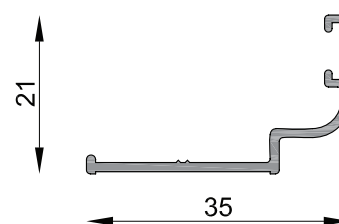

Encuentro central puerta de rebatir
Peso estimado: 0.192 Kg/m
Largo STD: 6030 mm

MT- 0838



Revestimiento puerta
Peso estimado: 0.780 Kg/m
Largo STD: 6030 mm

MT- 0841

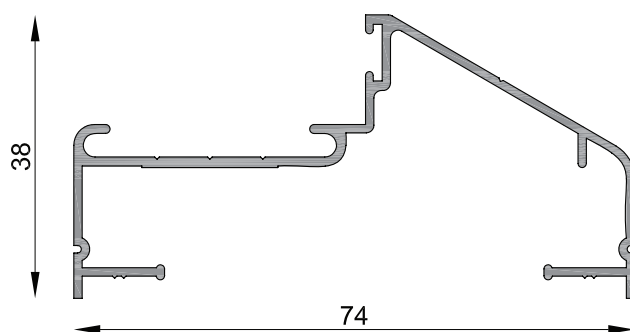

Marco puerta
Peso estimado: 0.543 Kg/m
Largo STD: 6150 mm

PUERTAS

PUERTAS - HOJA 25 mm

MT- 0950

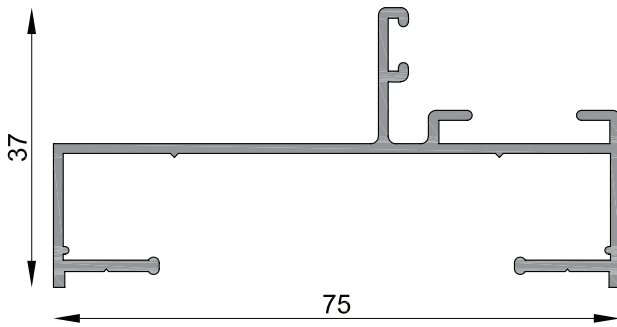

Marco recto
Peso estimado: 0.651 Kg/m
Largo STD: 6150 mm

MT- 0932

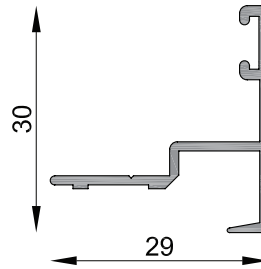

Solapa Central
Peso estimado: 0.243 Kg/m
Largo STD: 6030 mm

MT- 0951

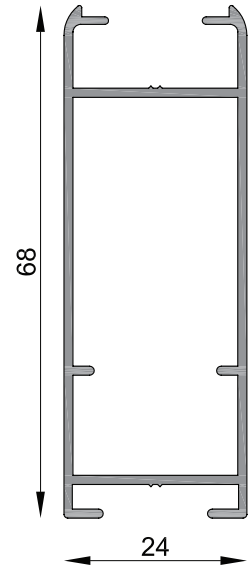

Parante Hoja
Peso estimado: 0.645 Kg/m
Largo STD: 6150 mm

MT- 0979

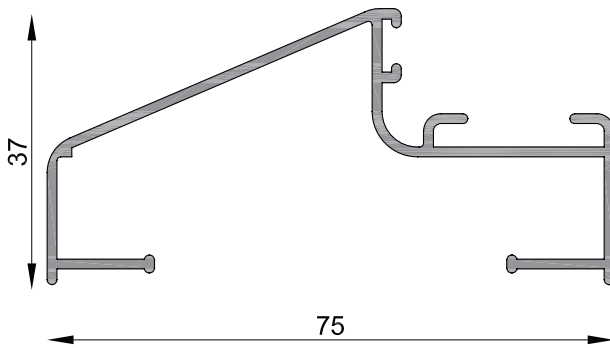

Marco puerta
Peso estimado: 0.626 Kg/m
Largo STD: 6150 mm

MT- 0967

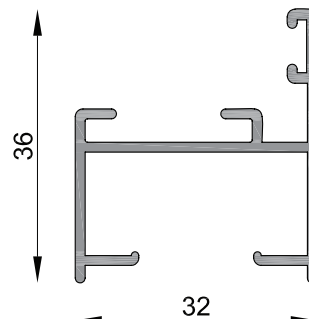

Marco simple de 31 mm
Peso estimado: 0.429 Kg/m
Largo STD: 6150 mm

POSTIGON Y TABLILLAS 25 mm

MT- 0153

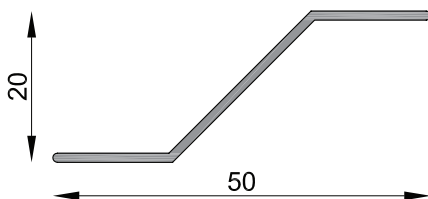

Tablilla fija para postigón
Peso estimado: 0.186 Kg/m
Largo STD: 6030 mm

MT- 0976

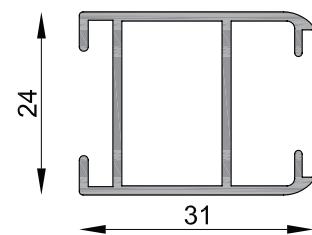

Parante hoja de postigón
Peso estimado: 0.389 Kg/m
Largo STD: 6150 mm

PUERTAS Y REVESTIMIENTOS

POSTIGON Y TABLILLAS 25 mm

MT- 0807

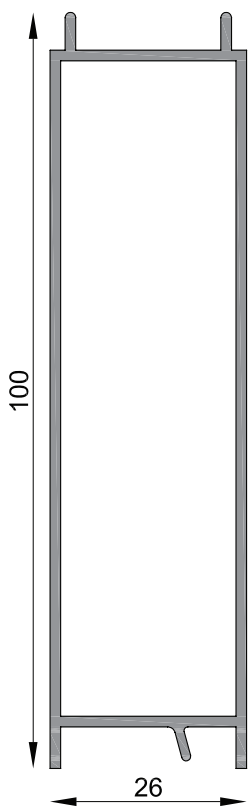

Tablilla tablero
Peso estimado: 0.945 Kg/m
Largo STD: 6030 mm

MT- 0993

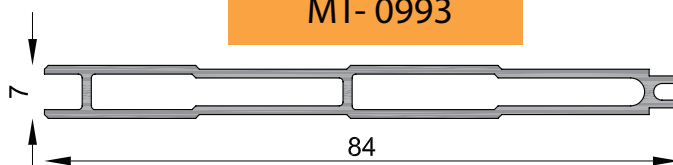

Revestimiento bajo relieve
Peso estimado: 0.564 Kg/m
Largo STD: 6030 mm

MT- 0963

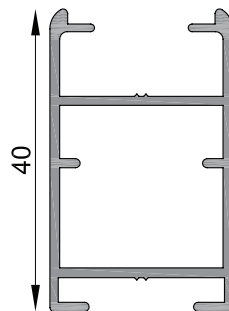

Parante hoja postigón
Peso estimado: 0.494 Kg/m
Largo STD: 6150 mm

MT- 0006

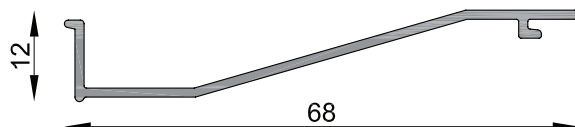

Tablilla Postigón
Peso estimado: 0.267 Kg/m
Largo STD: 6030 mm

MT- 0127

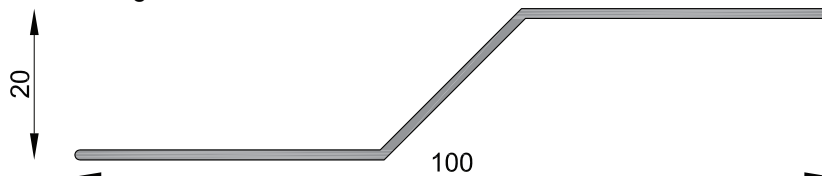

Tablilla fija para postigón
Peso estimado: 0.378 Kg/m
Largo STD: 6030 mm

MT- 0992

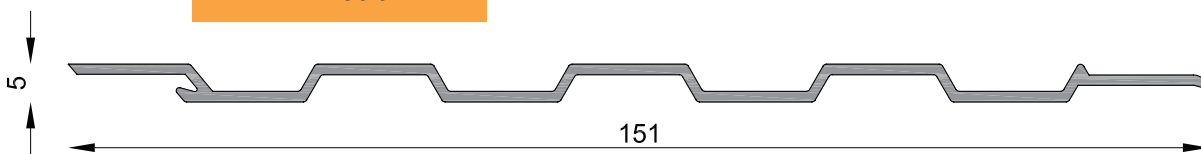

Revestimiento doble faz
Peso estimado: 0.635 Kg/m
Largo STD: 6030 mm

MT- 0995

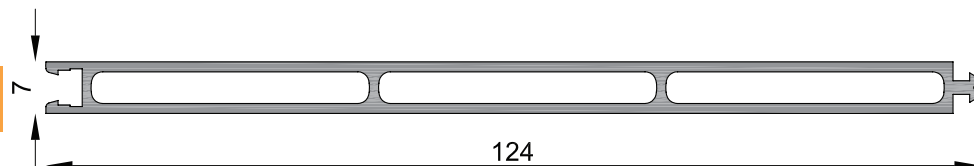

Revestimiento 7 mm
Peso estimado: 0.932 Kg/m
Largo STD: 6030 mm

USAR MARCOS DE HOJA 25mm

CORTINAS ENROLLAR

CORTINAS ENROLLAR

MT- 0922

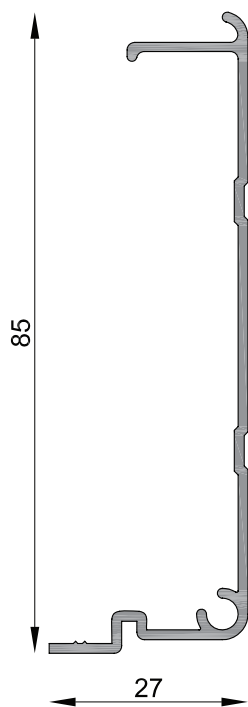

MT- 0920

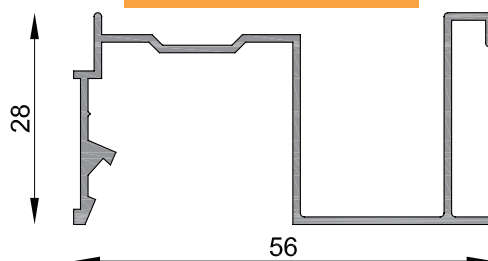

Guía cortina común
Peso estimado: 0.419 Kg/m
Largo STD: 6030 mm

MT- 0921

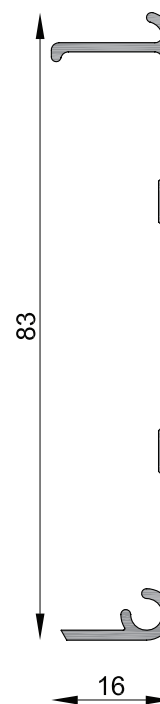

Soporte Tapa cinta
Peso estimado: 0.478 Kg/m
Largo STD: 6030 mm

Tapa cinta
Peso estimado: 0.413 Kg/m
Largo STD: 6030 mm

MT- 1982

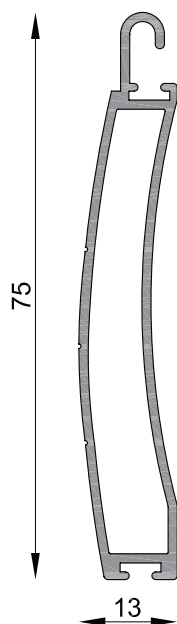

Zócalo de cortina
Peso estimado: 0.554 Kg/m
Largo STD: 6030 mm

MT- 0991

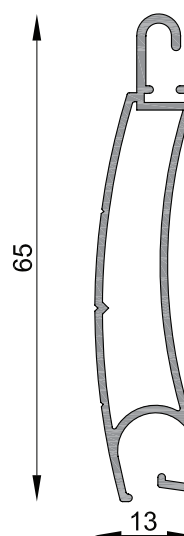

Tablilla de Cortina
Peso estimado: 0.424 Kg/m
Largo STD: 6030 mm

PARASOLES - TECHO - MAMPARA

MAMPARAS DE BAÑO

MT- 1101

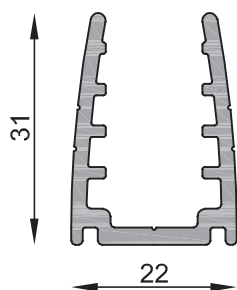

Marco Hoja para mampara
Peso estimado: 0.508 kg/m
Largo STD: 6030 mm

MT- 1102

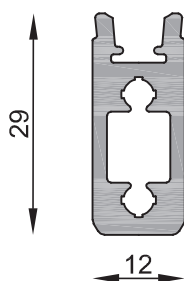

Soporte Hoja para mampara
Peso estimado: 0.548 kg/m
Largo STD: 6030 mm

MT- 1103

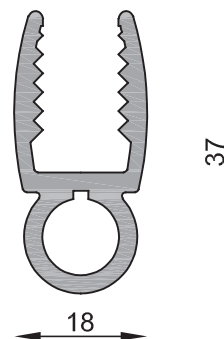

Hoja de mampara
Peso estimado: 0.635 kg/m
Largo STD: 6030mm

PARASOLES Y TECHO

MT- 0088

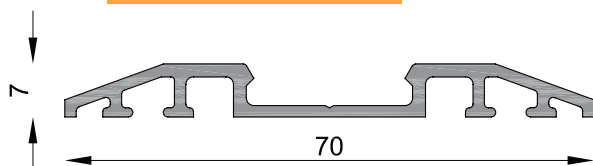

Tapa de travesaño
Peso estimado: 0.470 Kg/m
Largo STD: 6030 mm

MT- 0087

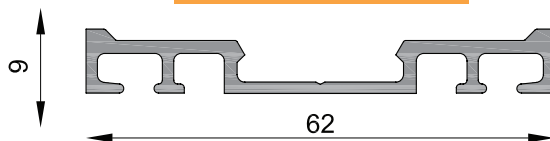

Tapa de larguero
Peso estimado: 0.486 Kg/m
Largo STD: 6030 mm

MT- 0318

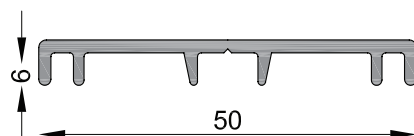

Tapa Policarbonato
Peso estimado: 0.327 Kg/m
Largo STD: 6030 mm

MT- 0089

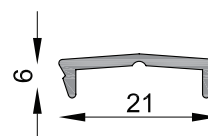

Cubre tornillos techos vidriados
Peso estimado: 0.111 Kg/m
Largo STD: 6030 mm

PARASOLES Y TECHO

PARASOLES Y TECHO

MT- 0085

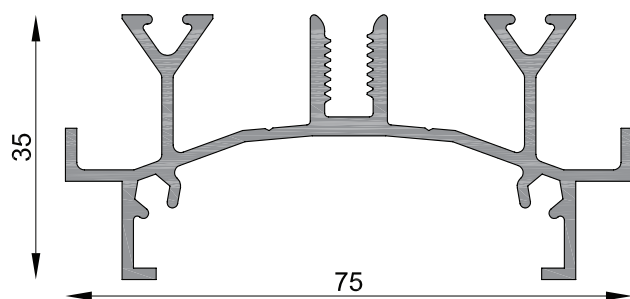

Larguero techo vidriado
Peso estimado: 1.010 Kg/m
Largo STD: 6030 mm

MT- 0086

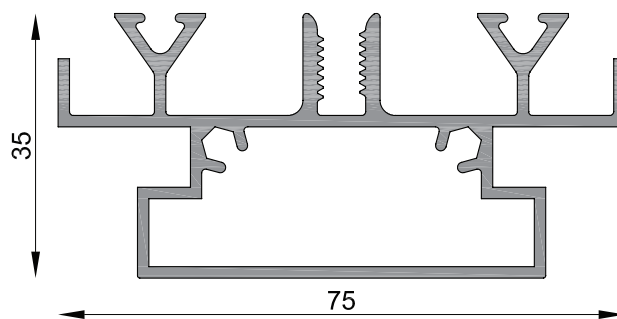

Travesaño techo vidriado
Peso estimado: 1.239 Kg/m
Largo STD: 6030 mm

MT- 0036

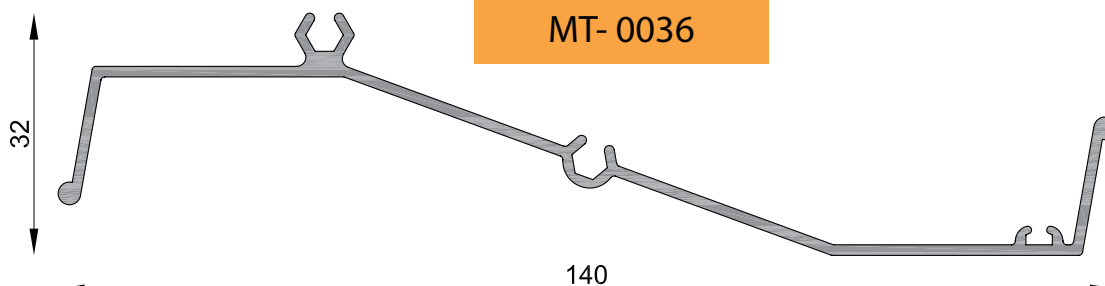

Tablilla parasol móvil
Peso estimado: 0.772 Kg/m
Largo STD: 6030 mm

MT- 0650

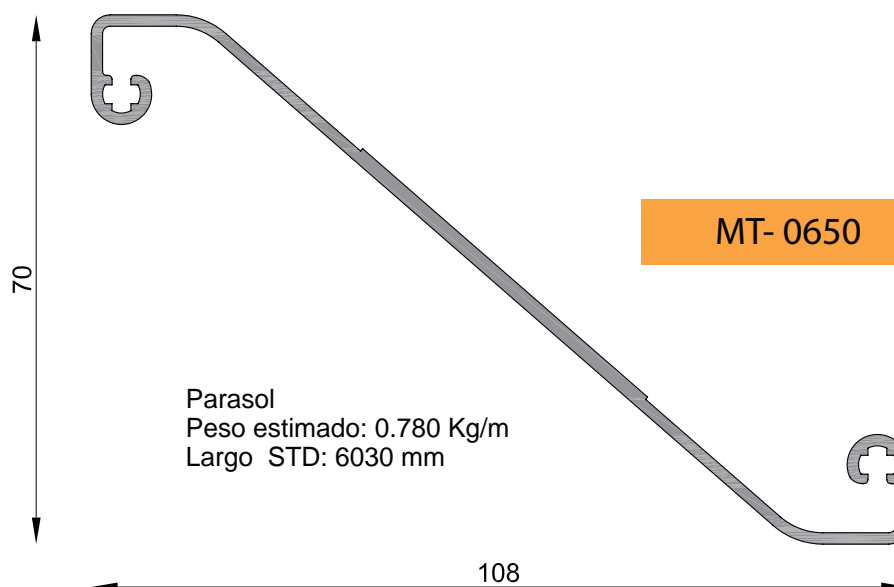

Parasol
Peso estimado: 0.780 Kg/m
Largo STD: 6030 mm

ACOPLES Y ESCUADRAS.

ACOPLES Y ESCUADRAS.

MT- 0949

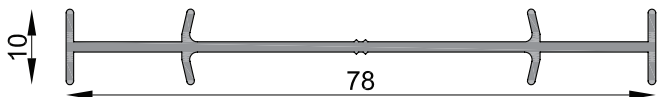

Acople Tapajunta 75 mm
Peso estimado: 0.381 Kg/m
Largo STD: 6030 mm

MT- 0988

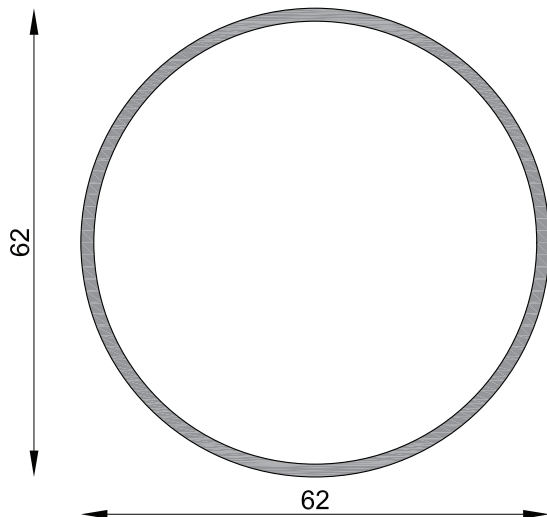

Columna rótula
Peso estimado: 0.869 Kg/m
Largo STD: 6030 mm

MT- 1870

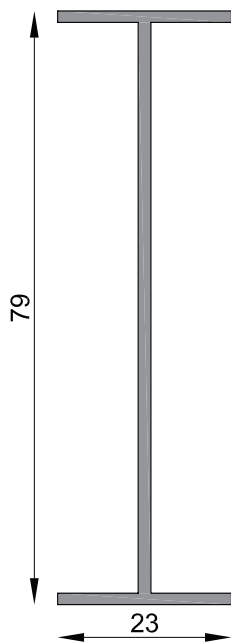

Perfil de unión
Peso estimado: 0.535 Kg/m
Largo STD: 6030 mm

MT- 0187

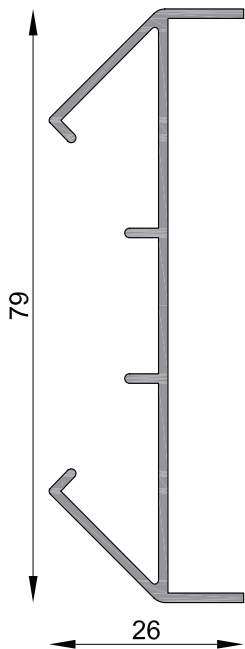

Apoyo rótula
Peso estimado: 0.518 Kg/m
Largo STD: 6030 mm

MT- 0186

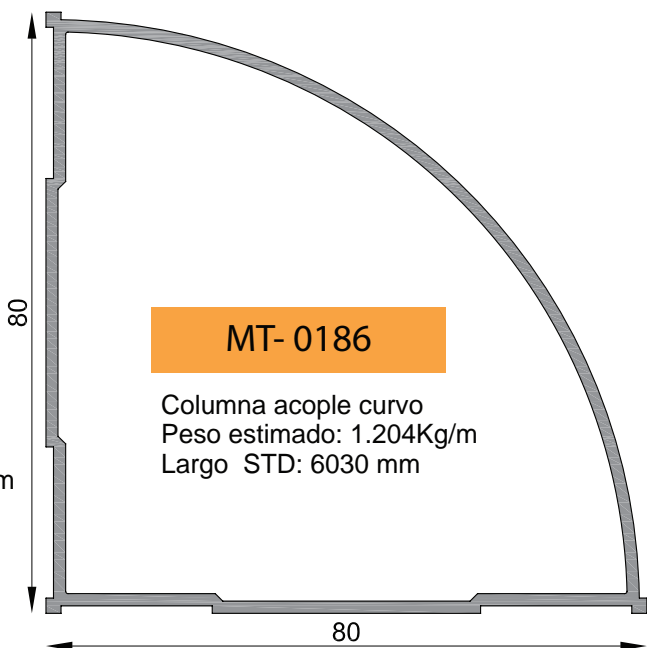

Columna acople curvo
Peso estimado: 1.204Kg/m
Largo STD: 6030 mm

ACOPLES Y ESCUADRAS

ACOPLES Y ESCUADRAS.

MT- 0185

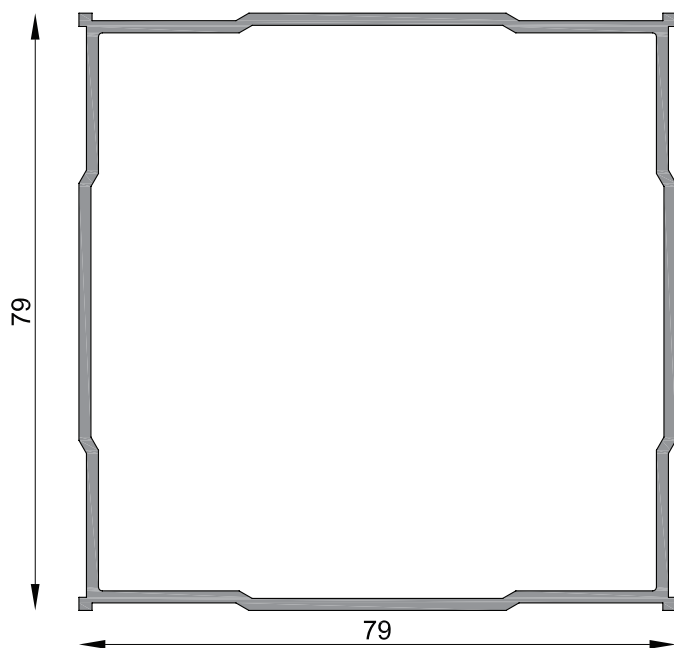

Columna acople recto
Peso estimado: 1.339 Kg/m
Largo STD: 6030 mm

MT- 0836

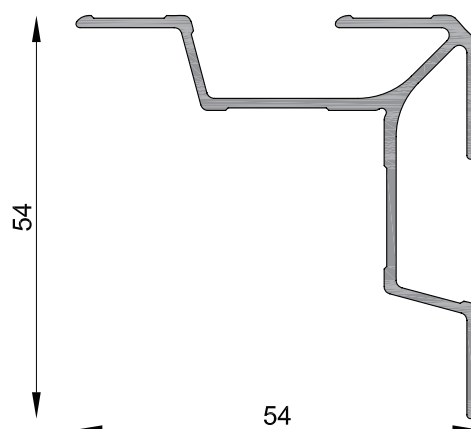

Escuadra universal liviana
Peso estimado: 0.548 Kg/m
Largo STD: 6030 mm

ADAPTADORES Y VIDRIOS REPARTIDOS

MT- 0019

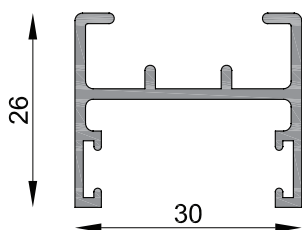

Cierre central hoja corrediza
Peso estimado: 0.381 Kg/m
Largo STD: 6030 mm

MT- 0919

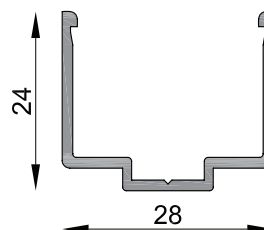

Adaptador para DVH h. corredizas
Peso estimado: 0.273 Kg/m
Largo STD: 6030 mm

PREMARCOS

PREMARCOS

MT- 73

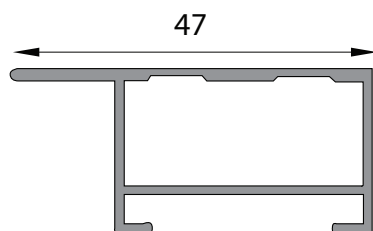

VITRINA

MT- 1089

MT- 1012

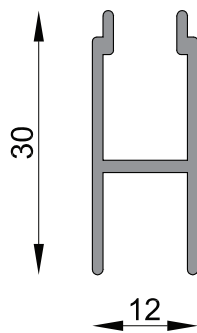

Umbral vitrina
Peso estimado: 0.240 Kg/m
Largo STD: 6030 mm

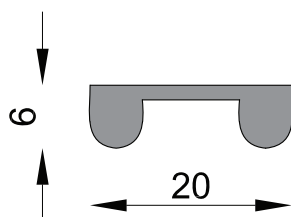

Riel vitrina
Peso estimado: 0.184 Kg/m
Largo STD: 6030 mm

MT- 1674

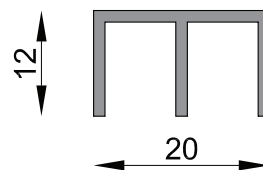

Dintel vitrina
Peso estimado: 0.184 Kg/m
Largo STD: 6030 mm

PLACARD

PLACARD

MT- 0600

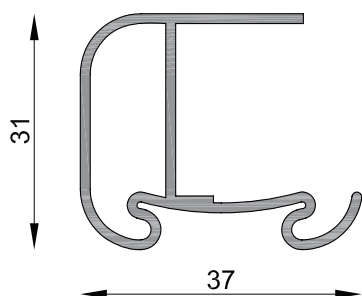

Parante placard
Peso estimado: 0.481 Kg/m
Largo STD: 6150 mm

MT- 0603

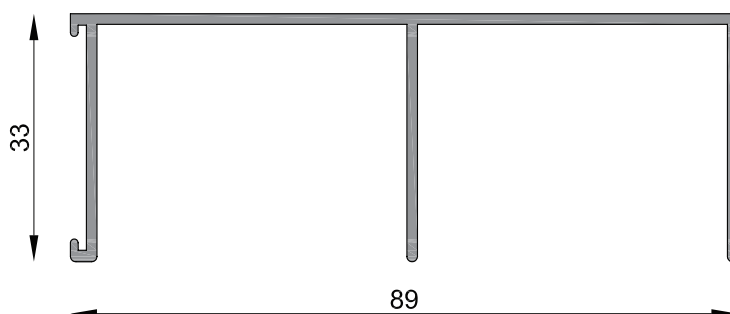

Dintel placard
Peso estimado: 0.705 Kg/m
Largo STD: 6030 mm

MT- 0601

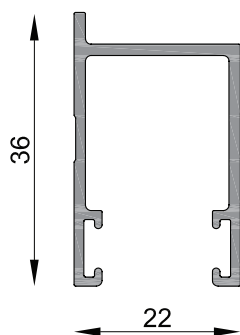

Zócalo placard
Peso estimado: 0.383 Kg/m
Largo STD: 6030 mm

MT- 0602

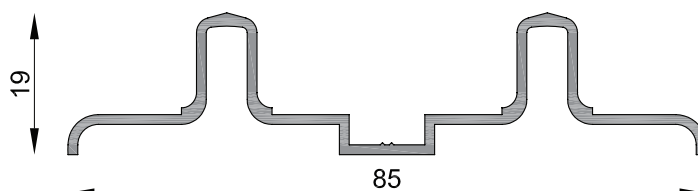

Guía placard
Peso estimado: 0.524 Kg/m
Largo STD: 6030 mm

PERFILES VARIOS - PLACARD

MT- 3034 / 01

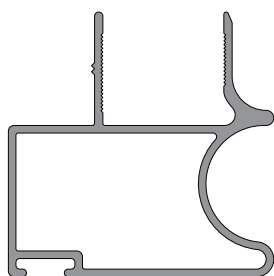

Frente placard
418 grs / mt.

MT- 3034 / 02

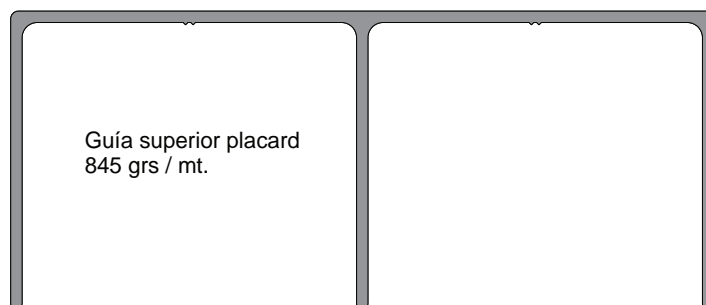

Guía superior placard
845 grs / mt.

MT- 3034 / 03



Guía inferior placard
308 grs / mt.
Paquete de 16 barras

VENTANA DE ABRIR

PLACARD **P45**

MT- 1090

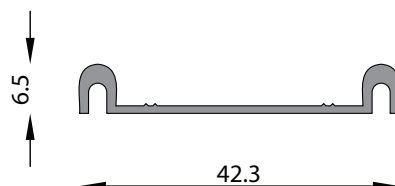

Guía Inferior
Peso estimado: 0.194 Kg/m
Largo STD: 6000 mm

MT- 1093

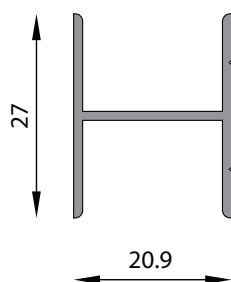

Travesaño hoja
Peso estimado: 0.232 Kg/m
Largo STD: 6000 mm

MT- 1092

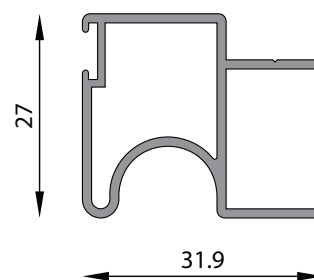

Parante placard
Peso estimado: 0.392 Kg/m
Largo STD: 5200 mm

MT- 1091

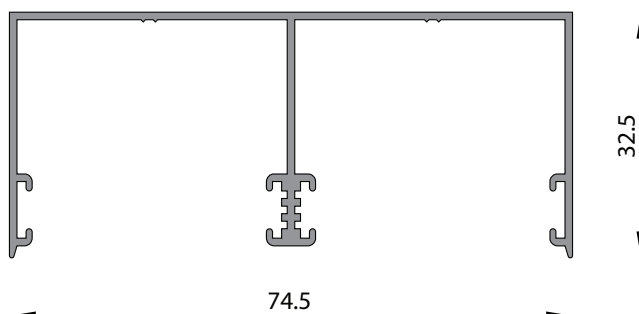

Guía Superior
Peso estimado: 0.535 Kg/m
Largo STD: 6000 mm

CORREDIZAS CORTE 90°

MARCOS - GUIA SIMPLE

MT- 0200

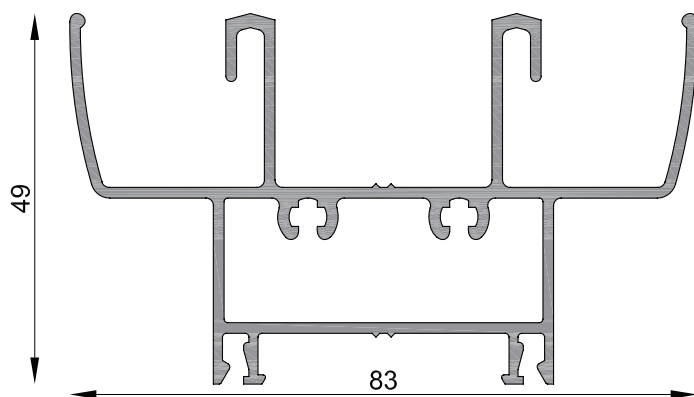

Umbral y dintel corrediza
Peso estimado: 1.266 Kg/m
Largo STD: 6150 mm

MT- 0201

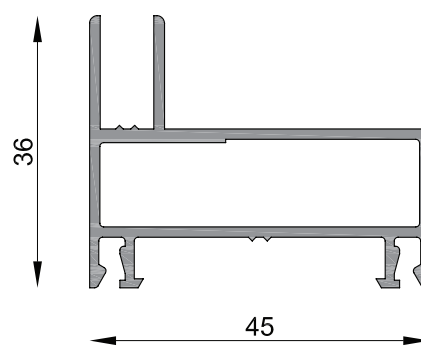

Jamba de marco
Peso estimado: 0.662 Kg/m
Largo STD: 6150 mm

MT- 57

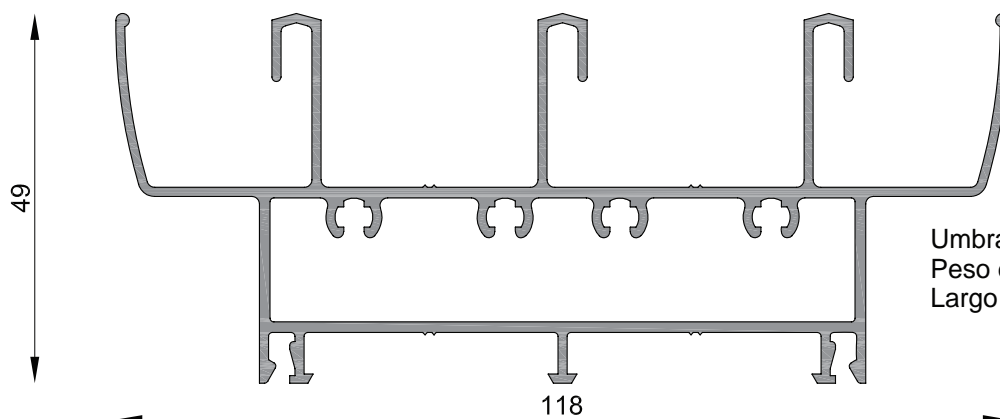
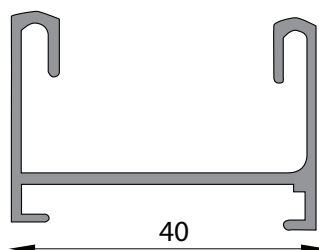

MT- 0240

Umbral y dintel marco tres guías
Peso estimado: 1.652 Kg/m
Largo STD: 6150 mm

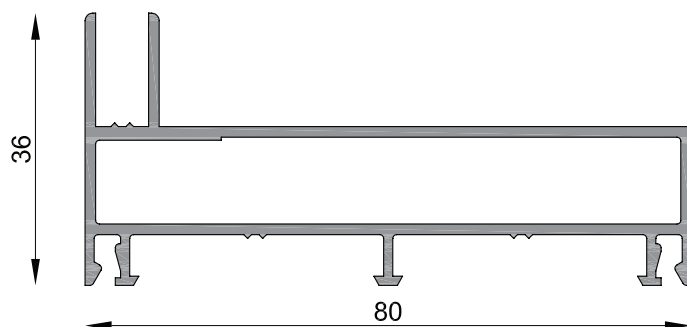

MT- 0241

Jamba de marco de tres guías
Peso estimado: 0.969 Kg/m
Largo STD: 6150 mm

CORREDIZAS CORTE 90°

HOJAS PARANTES

MT- 0207

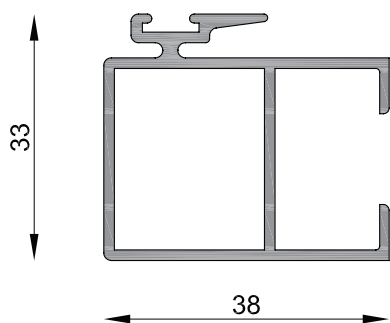

Parante central vidrio simple
Peso estimado: 0.613 Kg/m
Largo STD: 6150 mm

MT- 0208

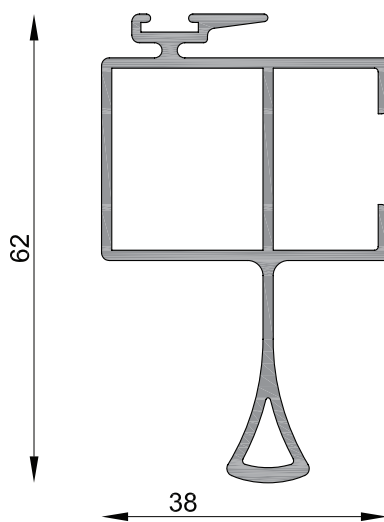

Parante central con asa vidrio simple
Peso estimado: 0.802 Kg/m
Largo STD: 6150 mm

MT- 0250

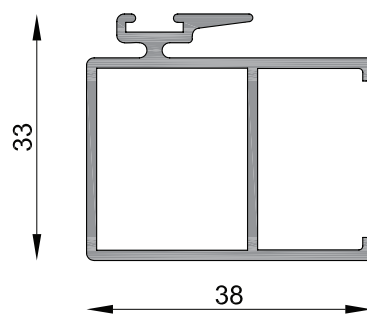

Parante central de hoja para DVH
Peso estimado: 0.567 Kg/m
Largo STD: 6150 mm

MT- 0251

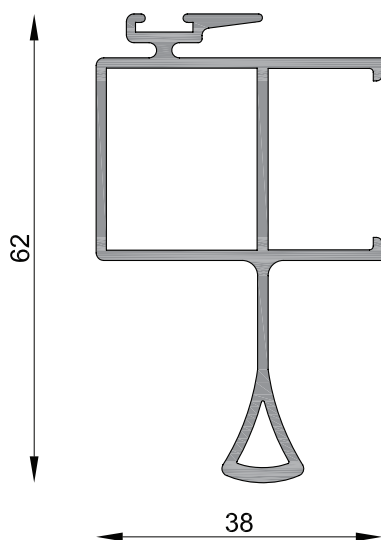

Parante central con tirador para DVH
Peso estimado: 0.780 Kg/m
Largo STD: 6150 mm

MT- 0203

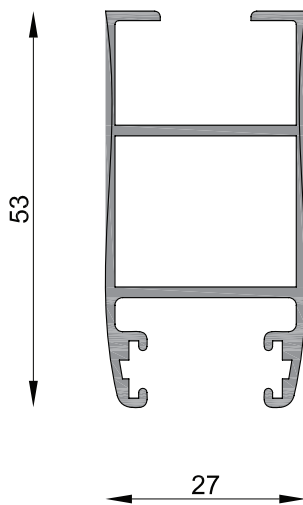

Parante lateral de hoja para vidrio simple
Peso estimado: 0.651 Kg/m
Largo STD: 6150 mm

MT- 0248

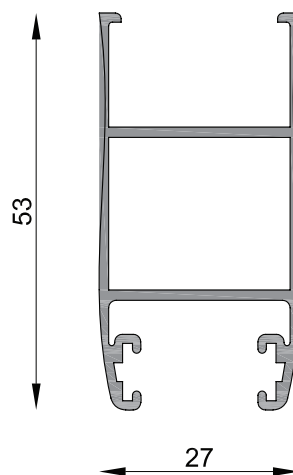

Parante lateral de hoja para DVH
Peso estimado: 0.608 Kg/m
Largo STD: 6150 mm

CORREDIZAS CORTE 90°

ZOCALOS

MT- 0209

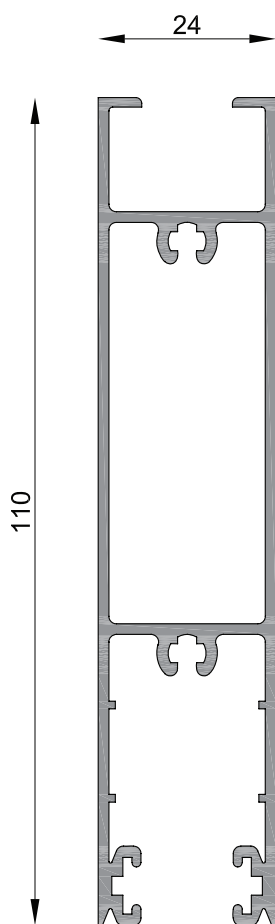

Zócalo alto
Peso estimado: 1.256 Kg/m
Largo STD: 6030 mm

MT- 0252

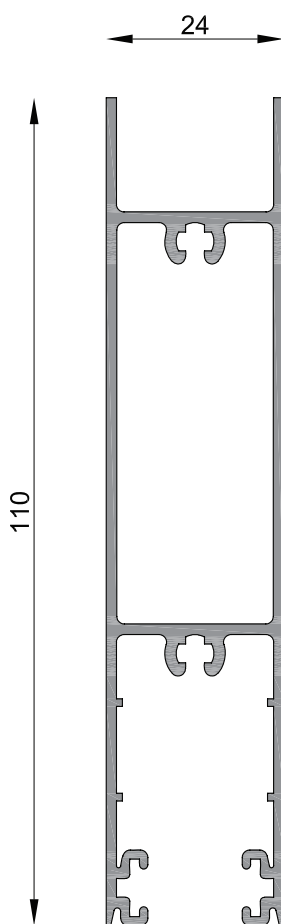

Zócalo alto de hoja para DVH
Peso estimado: 1.188 Kg/m
Largo STD: 6030 mm

MT- 0204

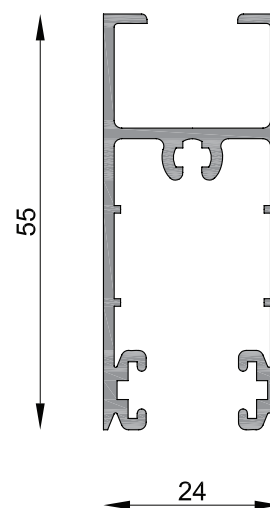

Zócalo y cabezal de hoja
Peso estimado: 0.705 Kg/m
Largo STD: 6030 mm

MT- 0249

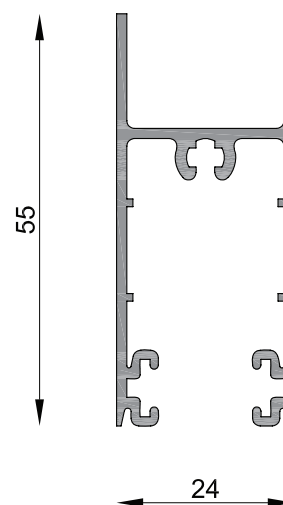

Zócalo y cabezal de hoja para DVH
Peso estimado: 0.632 Kg/m
Largo STD: 6030 mm

TRAVESAÑOS Y TAPAJUNTAS

MT- 0239

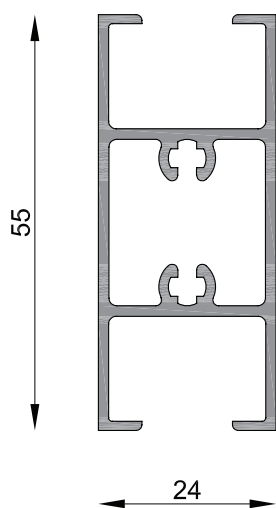

Travesaño hoja corrediza v. simple
Peso estimado: 0.724 Kg/m
Largo STD: 6030 mm

MT- 0253

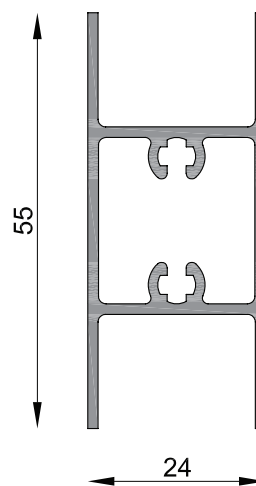

Travesaño de hoja para DVH
Peso estimado: 0.667 Kg/m
Largo STD: 6030 mm

MT- 3202

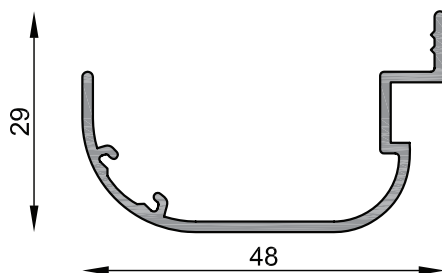

Tapa juntas
Peso estimado: 0.348 Kg/m
Largo STD: 6150 mm

AF-6031

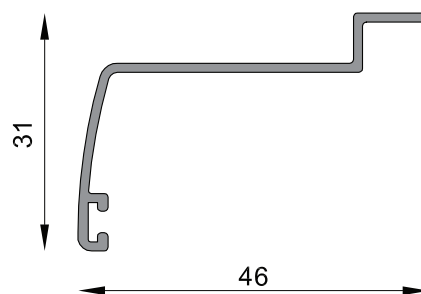

Contramarco desplazado interior
Peso estimado: 0.265 Kg/m
Largo STD: 6030 mm

CORREDIZAS CORTE 45°

CORREDIZAS CORTE 45° - HOJAS Y MARCOS

MT- 0330

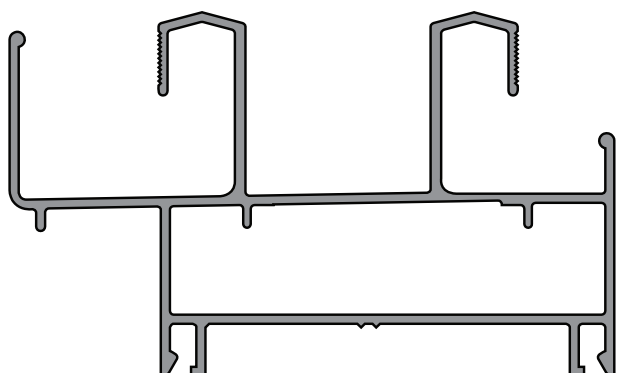

Marco liviano
Peso estimado: 1.066 Kg/m
Largo STD: 6150 mm

MT- 0383

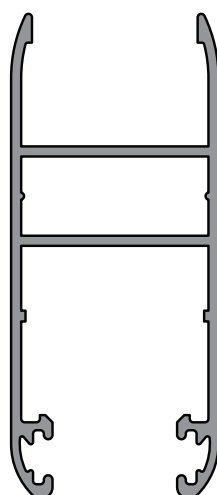

Hoja corrediza para v/s
Peso estimado: 0.794 Kg/m
Largo STD: 6200 mm

MT- 0016

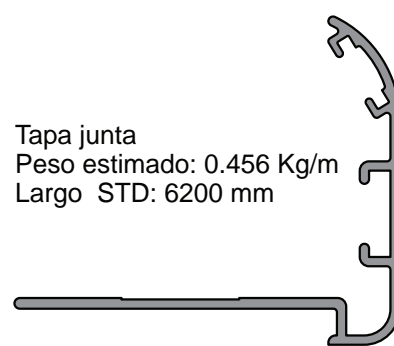

Tapa junta
Peso estimado: 0.456 Kg/m
Largo STD: 6200 mm

MT- 0325

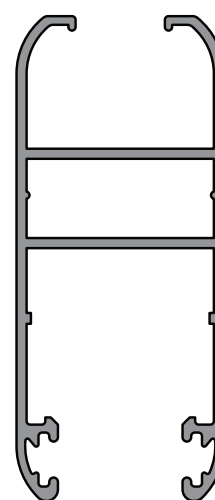

Hoja corrediza DVH
Peso estimado: 0.821 Kg/m
Largo STD: 6200 mm

MT- 0280

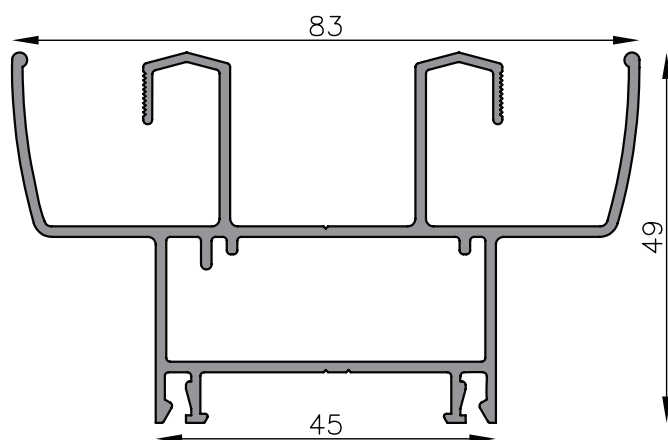

Marco Actual 45°
Peso estimado: 1.183 Kg/m

MT- 0316

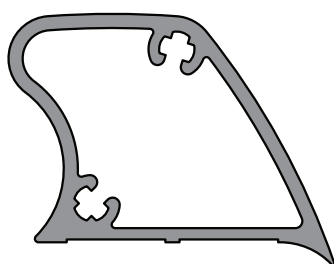

Hoja corrediza para v/s
Peso estimado: 0.794 Kg/m
Largo STD: 6200 mm

MT- 0342

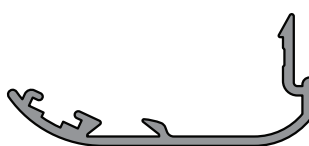

Tapa junta
Peso estimado: 0.065 Kg/m
Largo STD: 6200 mm

MT- 0315

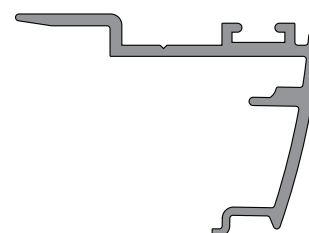

Solapa central ventana corrediza
Peso estimado: 0.381 Kg/m
Largo STD: 6200 mm

CORREDIZAS

GUIAS CORTINA Y PREMARCO

MT- 0205

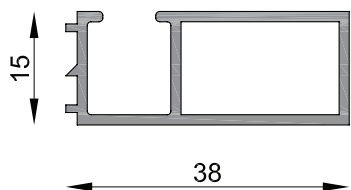

Premarco
Peso estimado: 0.383 Kg/m
Largo STD: 6150 mm

MT- 0254

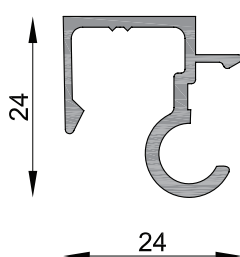

Bisagra tapa cinta
Peso estimado: 0.292 Kg/m
Largo STD: 6150 mm

MT- 0243

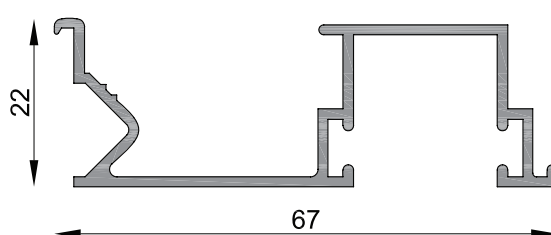

Guía de cortina común
Peso estimado: 0.545 Kg/m
Largo STD: 6150 mm

MT- 0244

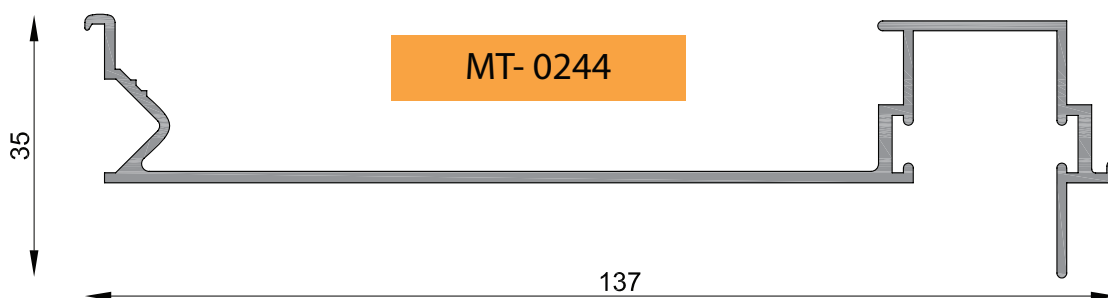

Guía de cortina barro
Peso estimado: 0.896 Kg/m
Largo STD: 6150 mm

MT- 0245

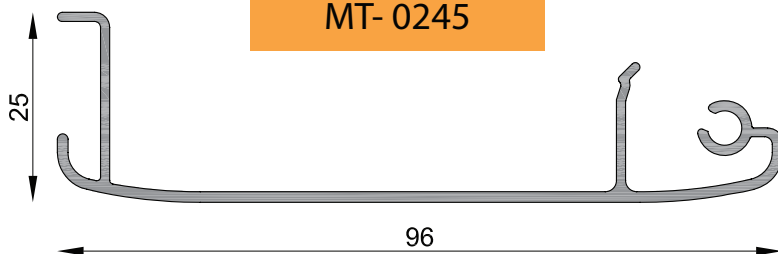

Tapa cinta
Peso estimado: 0.613 Kg/m
Largo STD: 6150 mm

MT- 2220

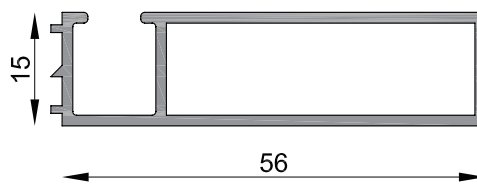

Premarco 56 mm
Peso estimado: 0.545 Kg/m
Largo STD: 6030 mm

CORREDIZAS

MOSQUITEROS

MT- 0255

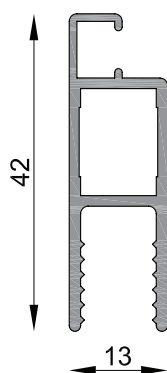

Mosquitero
Peso estimado: 0.389 Kg/m
Largo STD: 6030 mm

MT- 0228

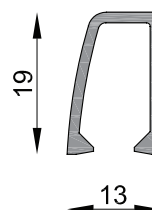

Tope mosquitero corrediza
Peso estimado: 0.186 Kg/m
Largo STD: 6030 mm

MT- 0256

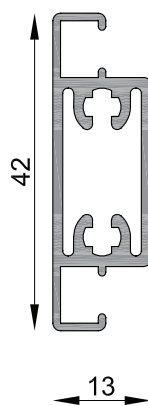

Travesaño mosquitero
Peso estimado: 0.446 Kg/m
Largo STD: 6030 mm

MT- 0326

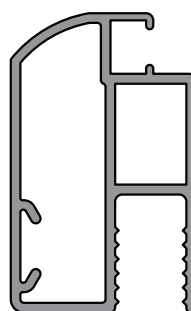

Hoja mosquitero
Peso estimado: 0.604 Kg/m
Largo STD: 6200 mm

PAÑO FIJO Y TRAVESAÑOS, MARCOS DE PUERTA, CONTRAVIDRIOS
ENCUENTRO CENTRAL DE ABRIR

MT- 0216

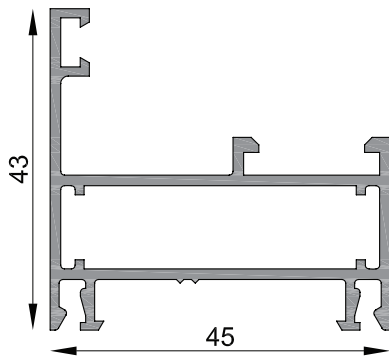

Marco ventana de abrir
Peso estimado: 0.726 Kg/m
Largo STD: 6150 mm

MT- 0221

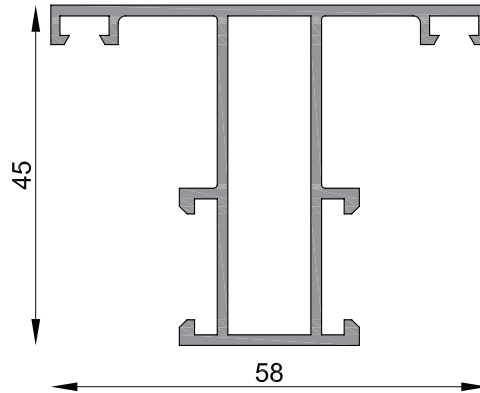

Travesaño angosto paño fijo
Peso estimado: 0.767 Kg/m
Largo STD: 6030 mm

MT- 0229

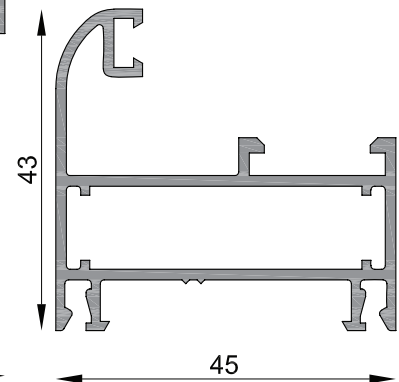

Paño fijo curvo
Peso estimado: 0.764 Kg/m
Largo STD: 6150 mm

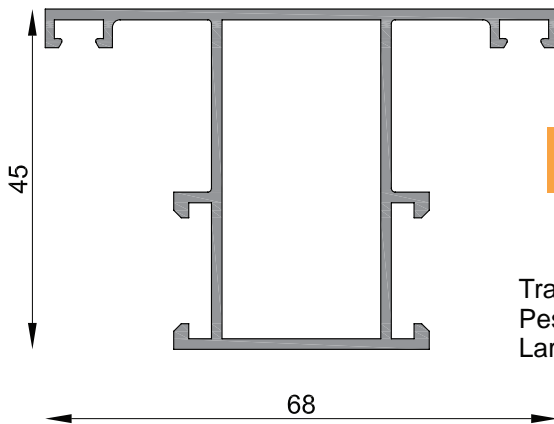

MT- 0222

Travesaño ancho paño fijo
Peso estimado: 0.840 Kg/m
Largo STD: 6030 mm

MT- 0263

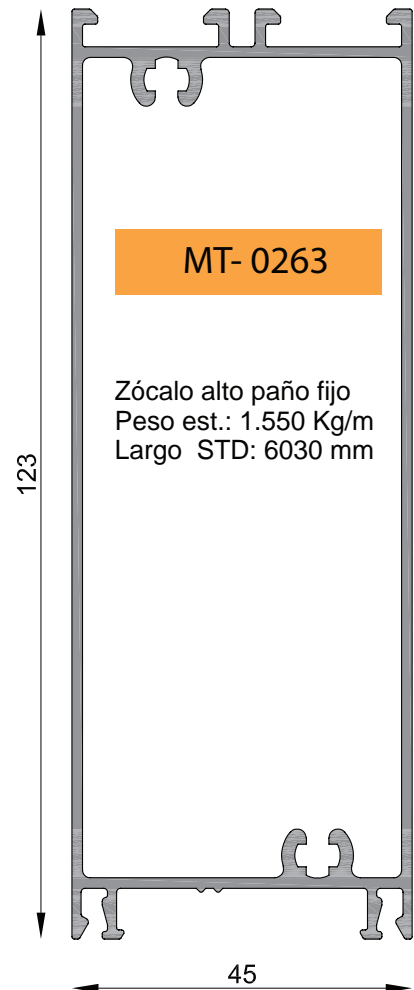

Zócalo alto paño fijo
Peso est.: 1.550 Kg/m
Largo STD: 6030 mm

MT- 0264

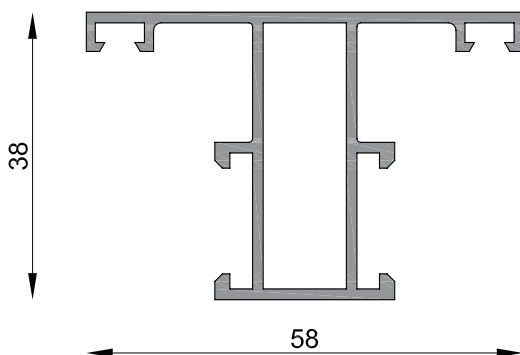

Travesaño paño fijo curvo
Peso estimado: 0.713 Kg/m
Largo STD: 6030 mm

PAÑO FIJO

PAÑO FIJO Y TRAVESAÑOS, MARCOS DE PUERTA, CONTRAVIDRIOS
ENCUENTRO CENTRAL DE ABRIR

MT- 0230

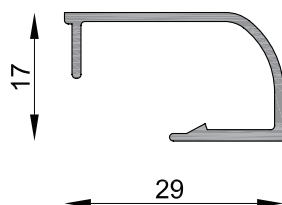

Contra vidrio curvo 29 mm
Peso estimado: 0.213 Kg/m
Largo STD: 6030 mm

MT- 0217

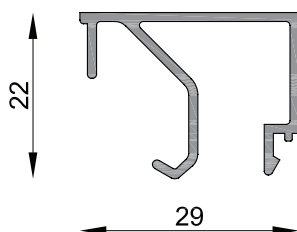

Contra vidrio 29 mm
Peso estimado: 0.292 Kg/m
Largo STD: 6030 mm

MT- 0226

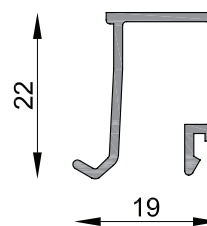

Contra vidrio
Peso estimado: 0.211 Kg/m
Largo STD: 6030 mm

MT- 0232

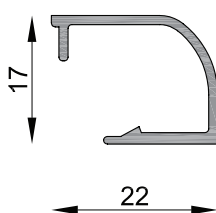

Contra vidrio curvo 22 mm
Peso estimado: 0.181 Kg/m
Largo STD: 6030 mm

MT- 0202

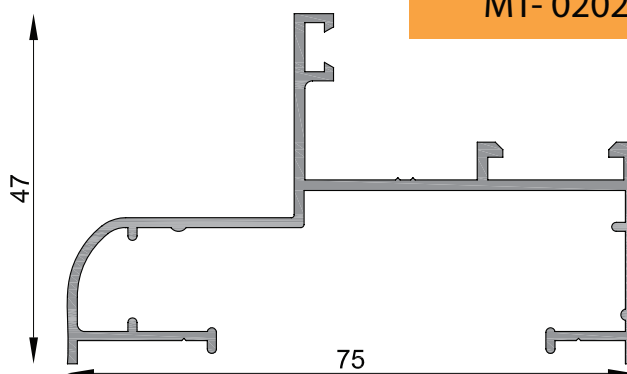

Marco 75 mm
Peso estimado: 0.716 Kg/m
Largo STD: 6150 mm

MT- 0224

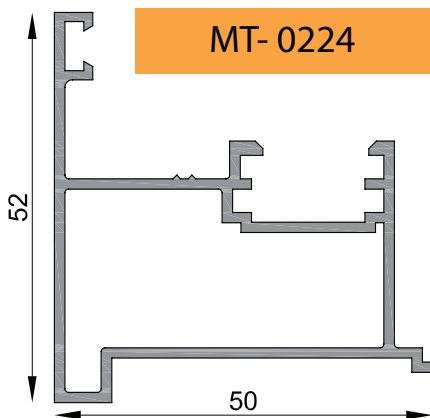

Encuentro central de abrir
Peso estimado: 0.780 Kg/m
Largo STD: 6030 mm

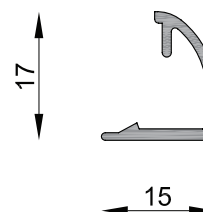

MT- 0233

Contra vidrio curvo 8 mm
Peso estimado: 0.135 Kg/m
Largo STD: 6030 mm

VENTANA ABRIR FRANCESA /OB

HOJA RECTA Y CURVA / CAMARA COMPENSADORA

MT- 0210

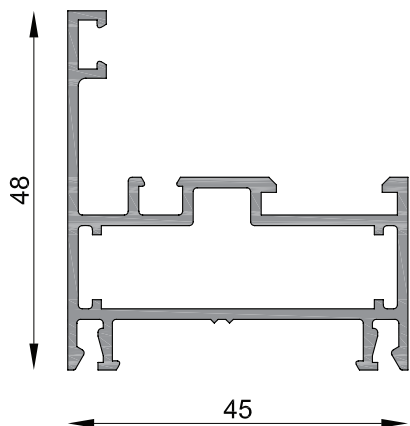

Marco ventana abrir
Peso estimado: 0.786 Kg/m
Largo STD: 6150 mm

MT- 0231

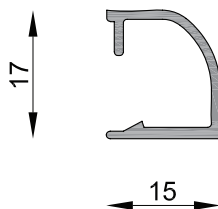

Contravidrio curvo 15 mm
Peso estimado: 0.159 Kg/m
Largo STD: 6030 mm

MT- 0211

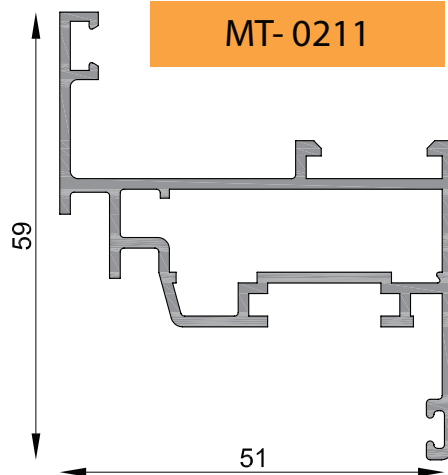

Hoja ventana de abrir
Peso estimado: 0.848 Kg/m
Largo STD: 6150 mm

MT- 0212

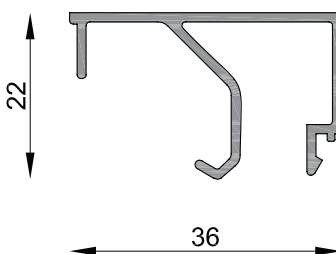

Contravidrio 36 mm
Peso estimado: 0.313 Kg/m
Largo STD: 6030 mm

MT- 0225

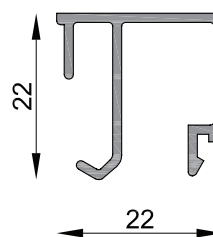

Contravidrio recto 22 mm
Peso estimado: 0.230 Kg/m
Largo STD: 6030 mm

MT- 0234

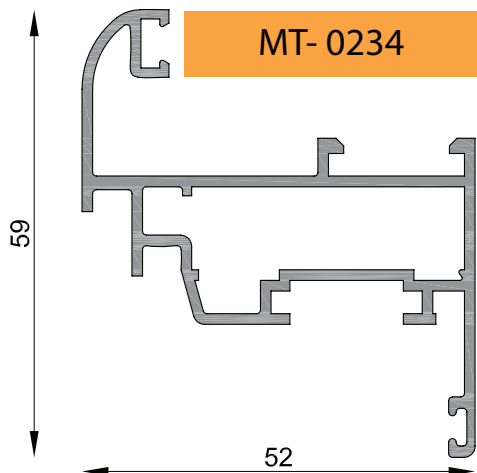

Hoja curva de abrir con cámara compensadora
Peso estimado: 0.886 Kg/m
Largo STD: 6150 mm

MT- 0230

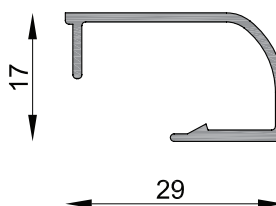

Contravidrio curvo 29 mm
Peso estimado: 0.213 Kg/m
Largo STD: 6030 mm

MT- 0206

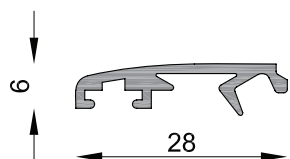

Contramarco
Peso estimado: 0.184 Kg/m
Largo STD: 6150 mm

VENTANA ABRIR FRANCESA / OB

HOJA CURVA Y RECTA / DOBLE CONTACTO

MT- 0215

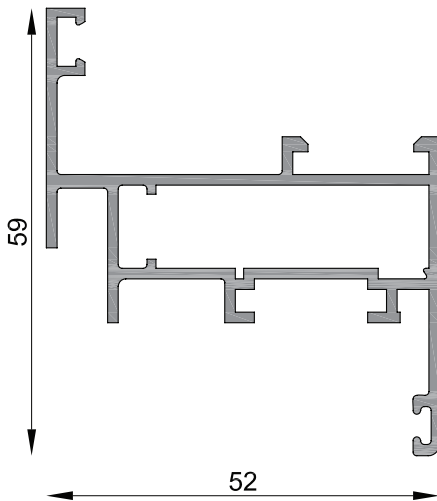

Hoja de abrir doble contacto
Peso estimado: 0.861 Kg/m
Largo STD: 6150 mm

MT- 0235

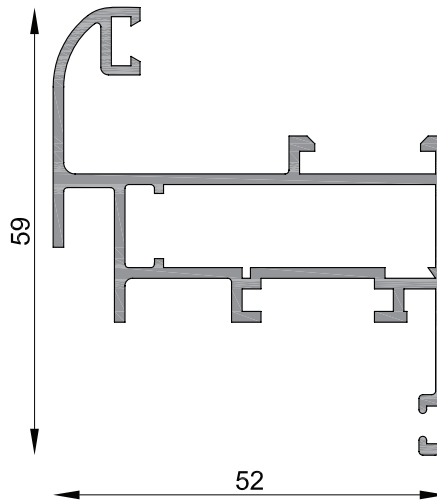

Hoja curva ventana de abrir doble contacto
Peso estimado: 0.902 Kg/m
Largo STD: 6030 mm

MT- 0216

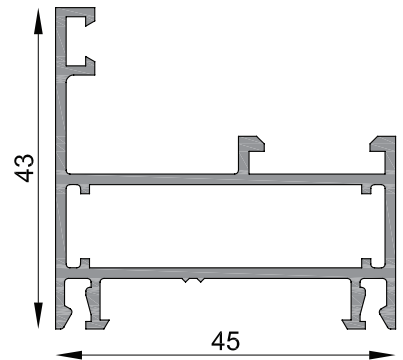

Marco ventana de abrir
Peso estimado: 0.726 Kg/m
Largo STD: 6150 mm

MT- 0225

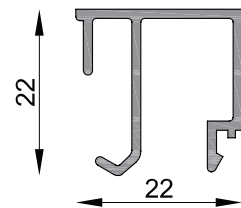

Contravidrio recto 22 mm
Peso estimado: 0.230 Kg/m
Largo STD: 6030 mm

MT- 0202

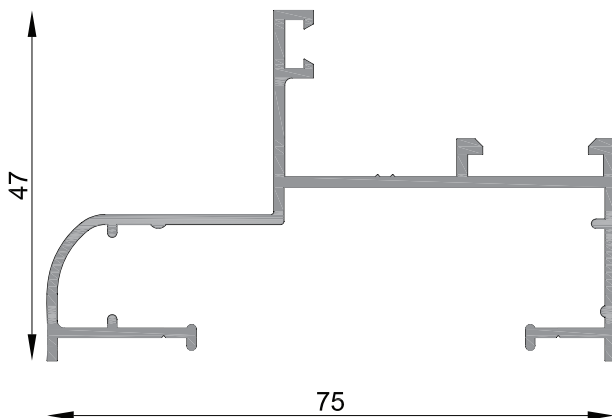

Marco 75 mm
Peso estimado: 0.716 Kg/m
Largo STD: 6150 mm

MT- 0231

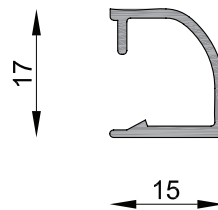

Contravidrio curvo 15 mm
Peso estimado: 0.159 Kg/m
Largo STD: 6030 mm

MT- 0212

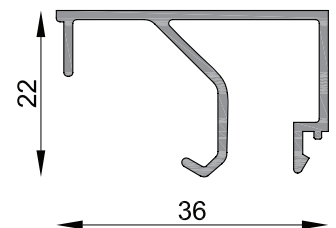

Contravidrio 36 mm
Peso estimado: 0.313 Kg/m
Largo STD: 6030 mm

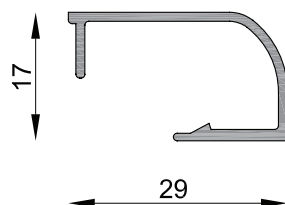

MT- 0230

Contravidrio curvo 29 mm
Peso estimado: 0.213 Kg/m
Largo STD: 6030 mm

VENTANA VENTILUZ

VENTILUZ RECTO

MT- 0212

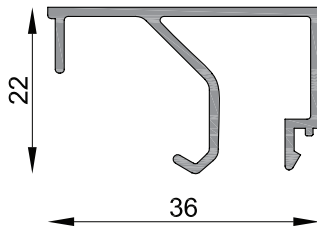

Contravidrio 36 mm
Peso estimado: 0.313 Kg/m
Largo STD: 6030 mm

MT- 0216

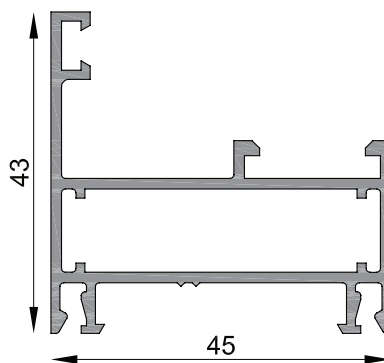

Marco ventana de abrir
Peso estimado: 0.726 Kg/m
Largo STD: 6150 mm

MT- 0225

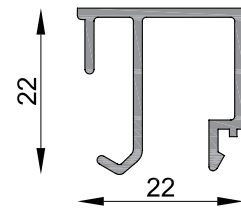

Contravidrio recto 22 mm
Peso estimado: 0.230 Kg/m
Largo STD: 6030 mm

MT- 0227

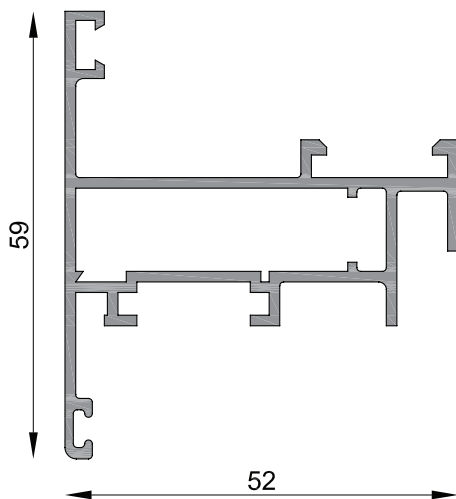

Hoja ventiluz
Peso estimado: 0.864 Kg/m
Largo STD: 6030 mm

MT- 0202

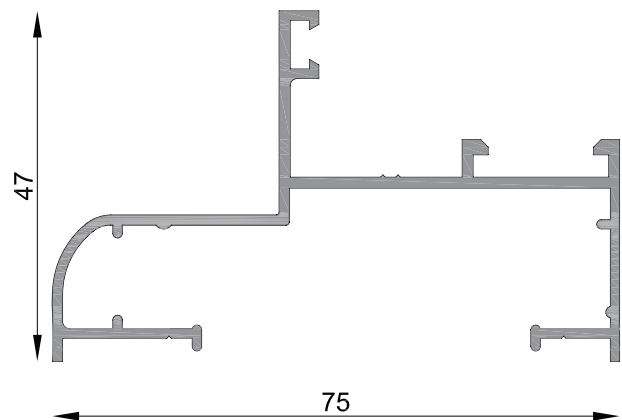

Marco 75 mm
Peso estimado: 0.716 Kg/m
Largo STD: 6130 mm

MT- 0206

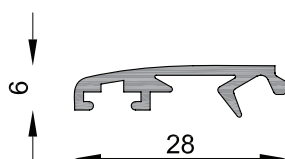

Contramarco
Peso estimado: 0.184 Kg/m
Largo STD: 6150 mm

VENTANA BANDEROLA

BANDEROLA / HOJA RECTA

MT- 0215

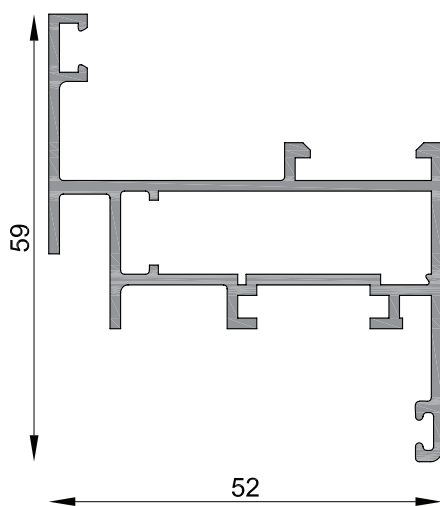

Hoja de abrir doble contacto
Peso estimado: 0.861 Kg/m
Largo STD: 6150 mm

MT- 0202

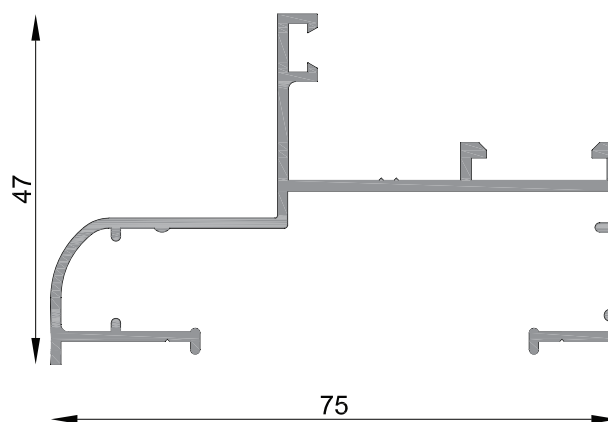

Marco 75 mm
Peso estimado: 0.716 Kg/m
Largo STD: 6150 mm

MT- 0212

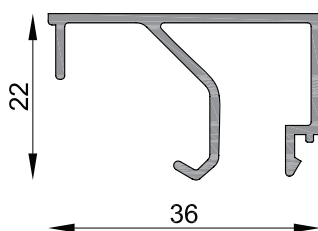

Contravidrio 36 mm
Peso estimado: 0.313 Kg/m
Largo STD: 6030 mm

MT- 0216

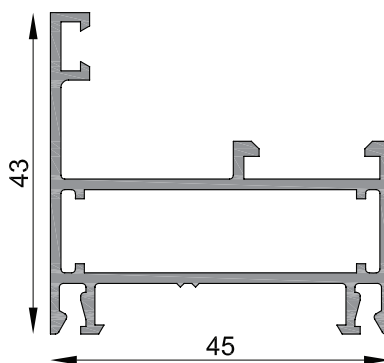

Marco ventana de abrir
Peso estimado: 0.726 Kg/m
Largo STD: 6150 mm

MT- 0225

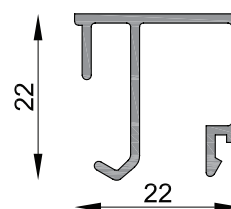

Contravidrio recto 22 mm
Peso estimado: 0.230 Kg/m
Largo STD: 6030 mm

MT- 0206

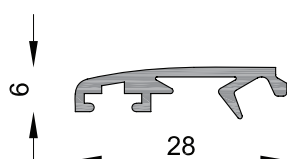

Contramarco
Peso estimado: 0.184 Kg/m
Largo STD: 6150 mm

VENTANA BANDEROLA

BANDEROLA / HOJA CURVA

MT- 0202

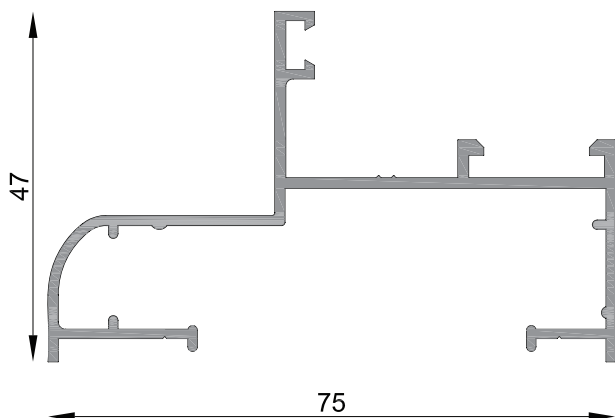

Marco 75 mm
Peso estimado: 0.716 Kg/m
Largo STD: 6150 mm

MT- 0235

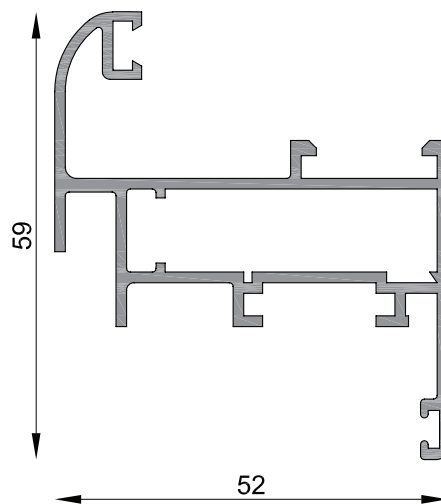

Hoja curva ventana de abrir doble contacto
Peso estimado: 0.902 Kg/m
Largo STD: 6030 mm

MT- 0216

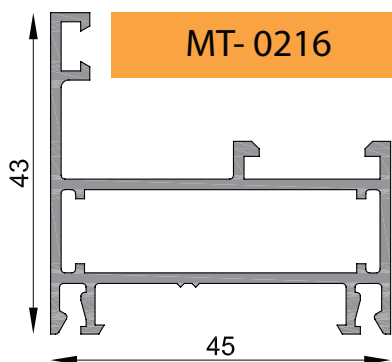

Marco ventana de abrir
Peso estimado: 0.726 Kg/m
Largo STD: 6150 mm

MT- 0230

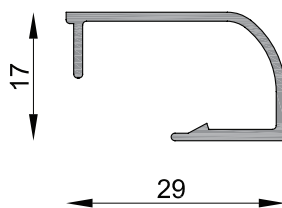

Contravidrio curvo 29 mm
Peso estimado: 0.213 Kg/m
Largo STD: 6030 mm

MT- 0231

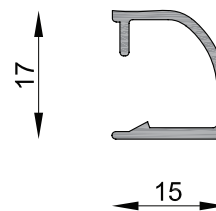

Contravidrio curvo 15 mm
Peso estimado: 0.159 Kg/m
Largo STD: 6030 mm

MT- 0206

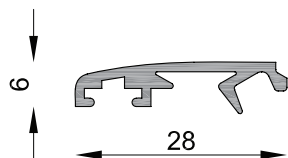

Contramarco
Peso estimado: 0.184 Kg/m
Largo STD: 6150 mm

VENTANA VENTILUZ

VENTILUZ / HOJA CURVA

MT- 0236

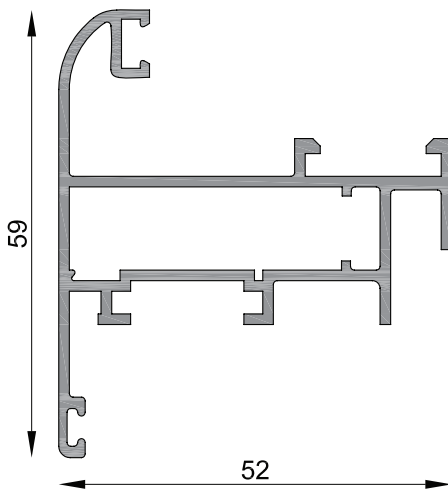

Hoja ventiluz curva
Peso estimado: 0.902 Kg/m
Largo STD: 6150 mm

MT- 0216

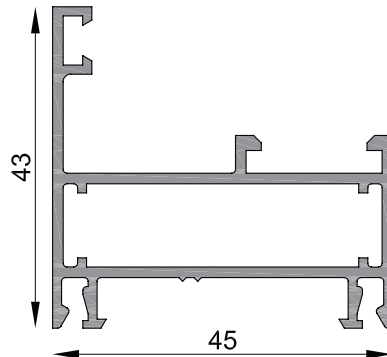

Marco ventana de abrir
Peso estimado: 0.726 Kg/m
Largo STD: 6150 mm

MT- 0231

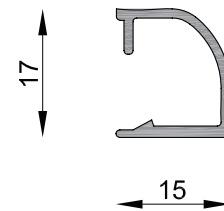

Contravidrio curvo 15 mm
Peso estimado: 0.159 Kg/m
Largo STD: 6030 mm

MT- 0202

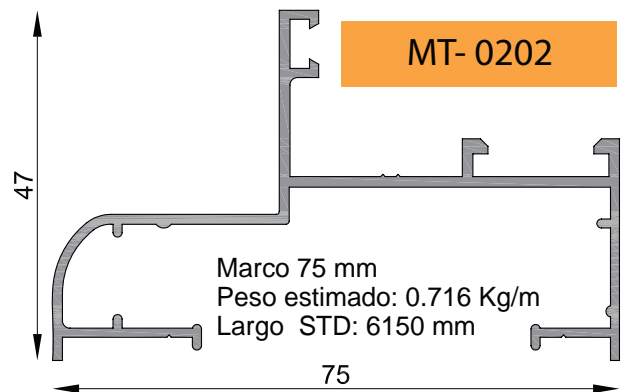

Marco 75 mm
Peso estimado: 0.716 Kg/m
Largo STD: 6150 mm

MT- 0230

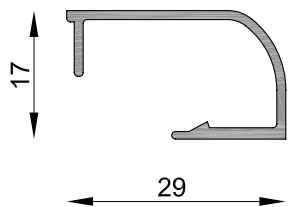

Contravidrio curvo 29 mm
Peso estimado: 0.213 Kg/m
Largo STD: 6030 mm

VENTANA DE ABRIR

HOJAS CON CONTRAVIDRIO INCORPORADO

MT- 0216

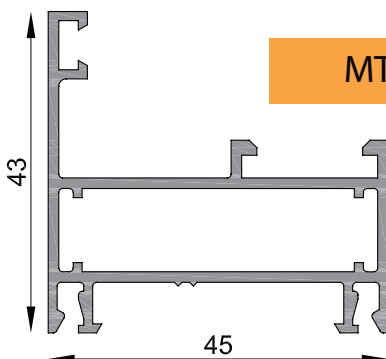

Marco ventana de abrir
Peso estimado: 0.726 Kg/m
Largo STD: 6150 mm

MT- 0202

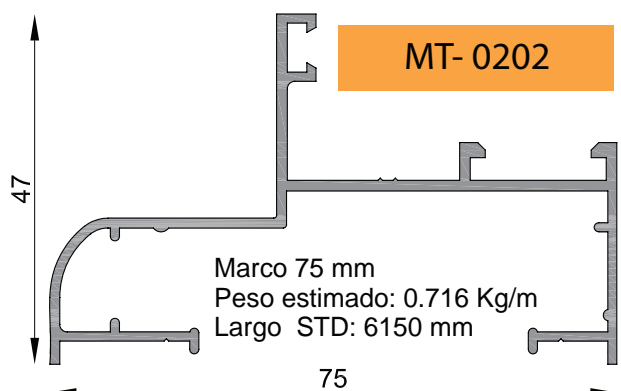

Marco 75 mm
Peso estimado: 0.716 Kg/m
Largo STD: 6150 mm

VENTANA DE ABRIR

HOJASCON CONTRAVIDRIO INCORPORADO

MT- 1211

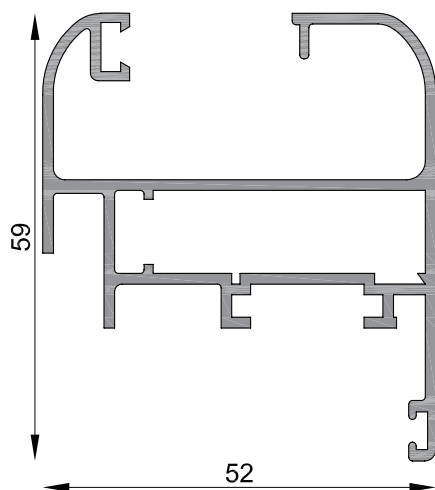

Hoja ventana de abrir DVH sin contravidrios
 Peso estimado: 0.999 Kg/m
 Largo STD: 6150 mm

MT- 0206

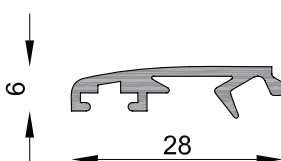

Contramarco
 Peso estimado: 0.184 Kg/m
 Largo STD: 6150 mm

MT- 2210

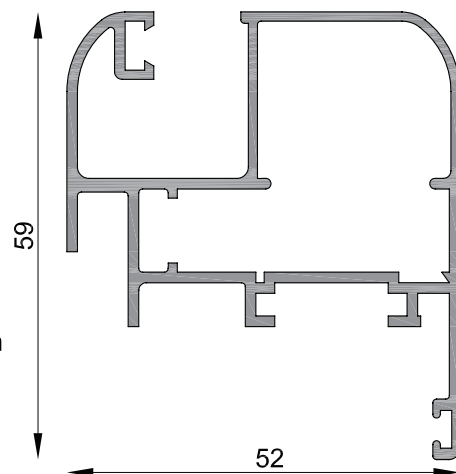

Hoja ventana de abrir doble contacto / banderola
 Peso estimado: 0.983 Kg/m
 Largo STD: 6030 mm

VENTANA DESPLAZABLE

DESPLAZABLE O PROYECTANTE (CON TIJERAS INOX.)

MT- 0212

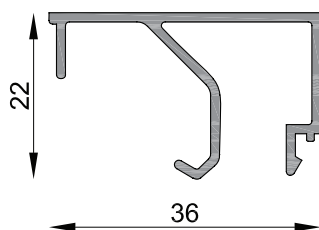

Contra Vidrio 36 mm
 Peso estimado: 0.313 Kg/m
 Largo STD: 6030 mm

MT- 0231

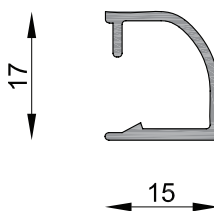

Contra Vidrio curvo 15 mm
 Peso estimado: 0.159 Kg/m
 Largo STD: 6030 mm

MT- 0225

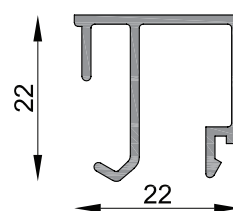

Contra Vidrio recto 22 mm
 Peso estimado: 0.230 Kg/m
 Largo STD: 6030 mm

MT- 0230

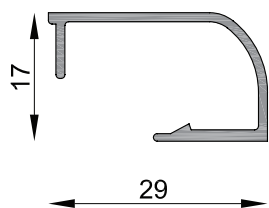

Contra Vidrio curvo 29 mm
 Peso estimado: 0.213 Kg/m
 Largo STD: 6030 mm

MT- 0206

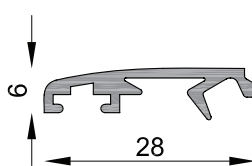

Contramarco
 Peso estimado: 0.184 Kg/m
 Largo STD: 6150 mm

VENTANA DESPLAZABLE

DESPLAZABLE O PROYECTANTE (CON TIJERAS INOX.)

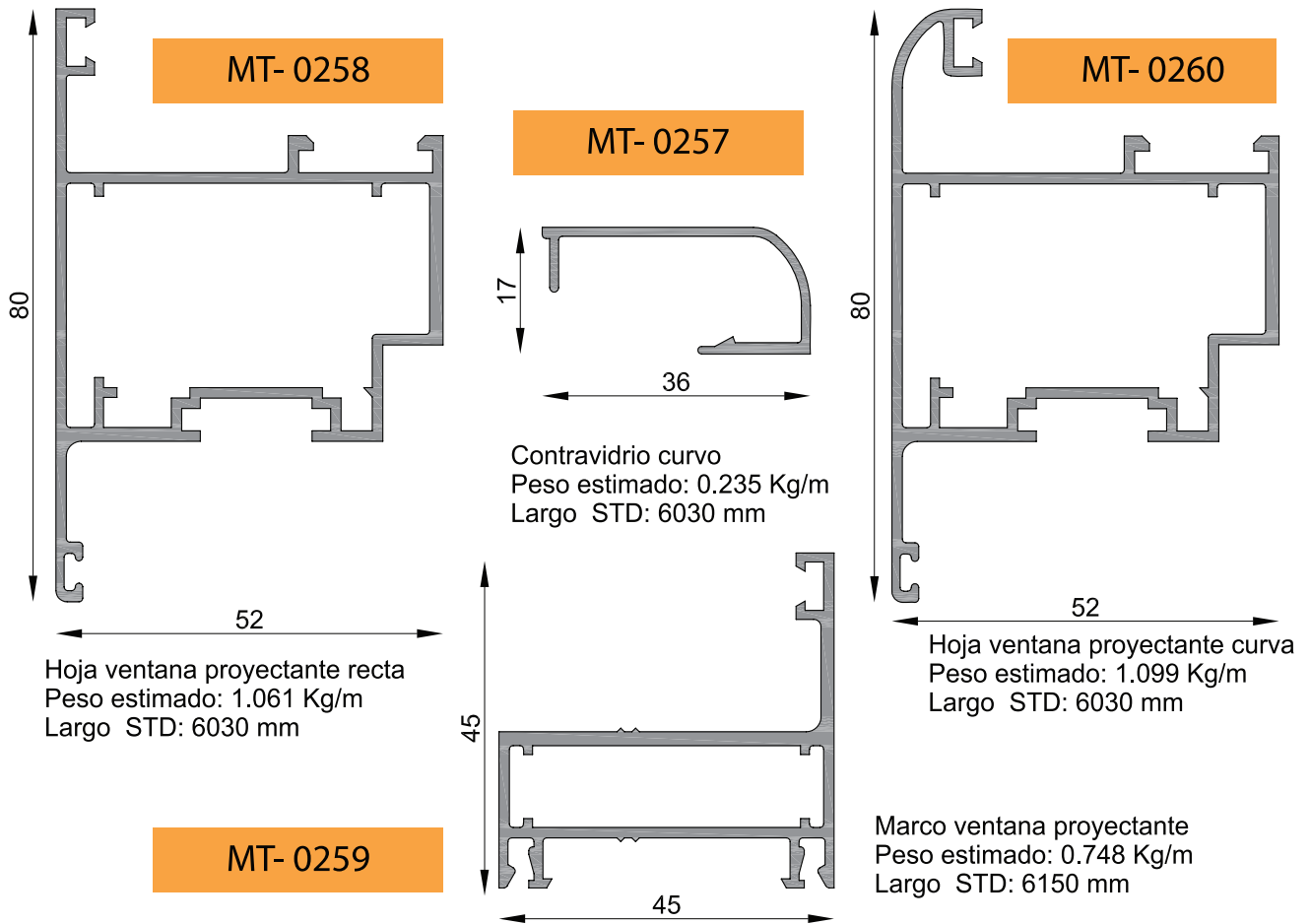

PUERTAS DE ABRIR

PUERTA DOBLE CONTACTO

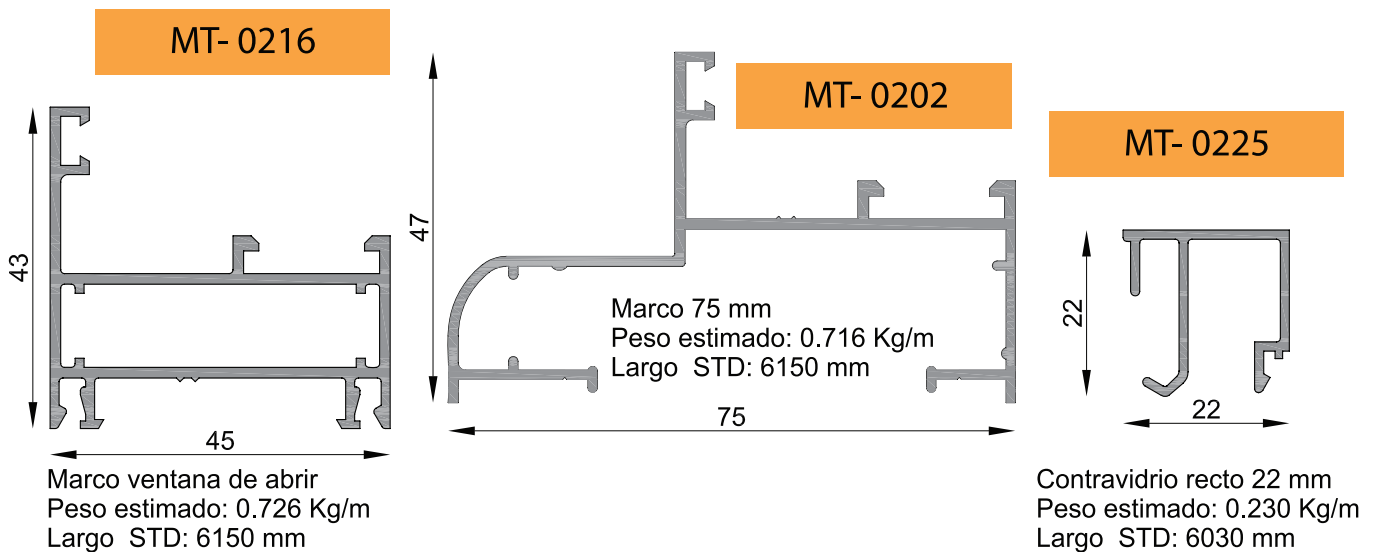

PUERTAS DE ABRIR

PUERTA DOBLE CONTACTO

MT- 0212

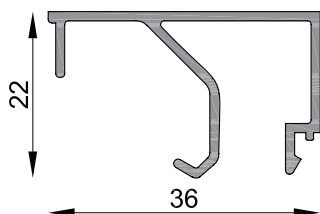

Contravidrio 36 mm
Peso estimado: 0.313 Kg/m
Largo STD: 6030 mm

MT- 0231

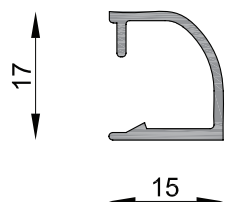

Contravidrio curvo 15 mm
Peso estimado: 0.159 Kg/m
Largo STD: 6030 mm

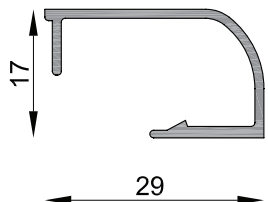

MT- 0230

Contravidrio curvo 29 mm
Peso estimado: 0.213 Kg/m
Largo STD: 6030 mm

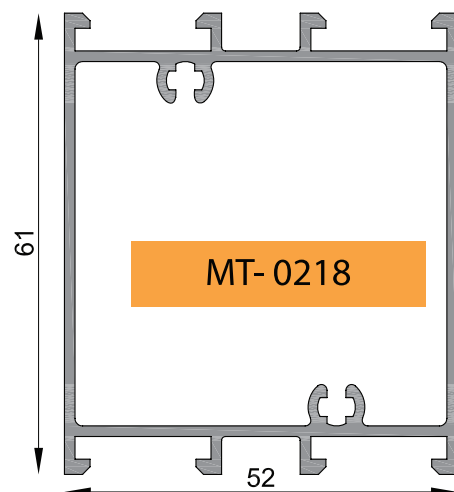

MT- 0218

Travesaño hoja puerta de rebatir
Peso estimado: 1.085 Kg/m
Largo STD: 6030 mm

MT- 0219

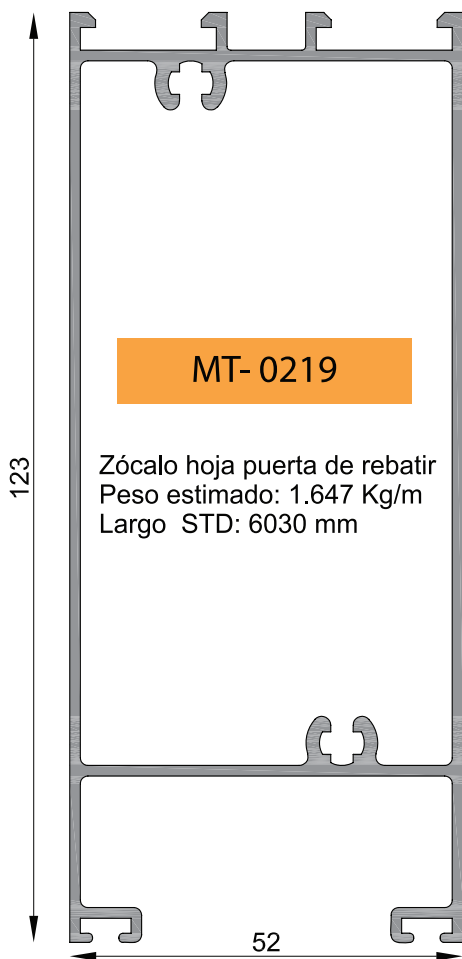

Zócalo hoja puerta de rebatir
Peso estimado: 1.647 Kg/m
Largo STD: 6030 mm

MT- 0214

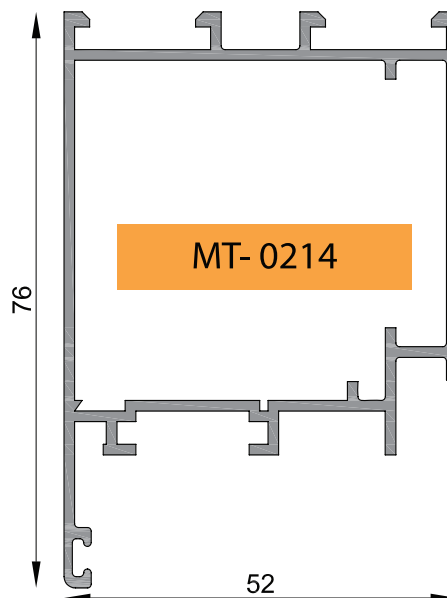

Jamba y cabezal hoja de puerta de rebatir
Peso estimado: 1.088Kg/m
Largo STD: 6150 mm

MT- 0220

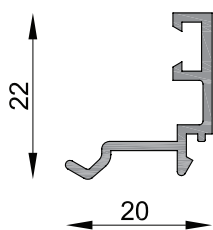

Contravidrio exterior puerta de rebatir
Peso estimado: 0.176 Kg/m
Largo STD: 6030 mm

PUERTAS DE ABRIR DOBLE CONTACTO

HOJA CON CONTRAVIDRIO INCORPORADO

MT- 0216

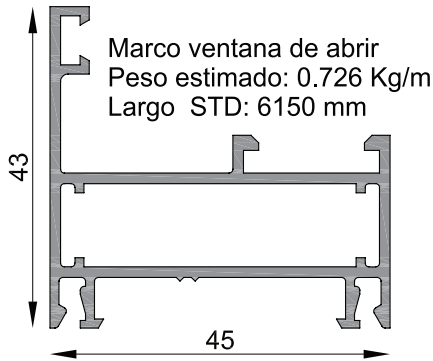

MT- 0231

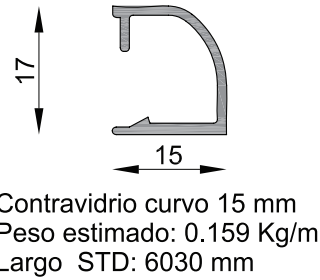

MT- 1273

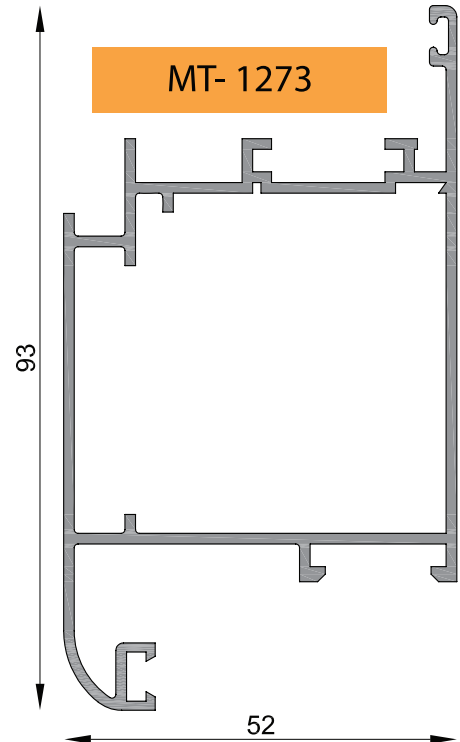

MT- 0206

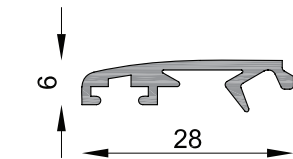

Contramarco
Peso estimado: 0.184 Kg/m
Largo STD: 6150 mm

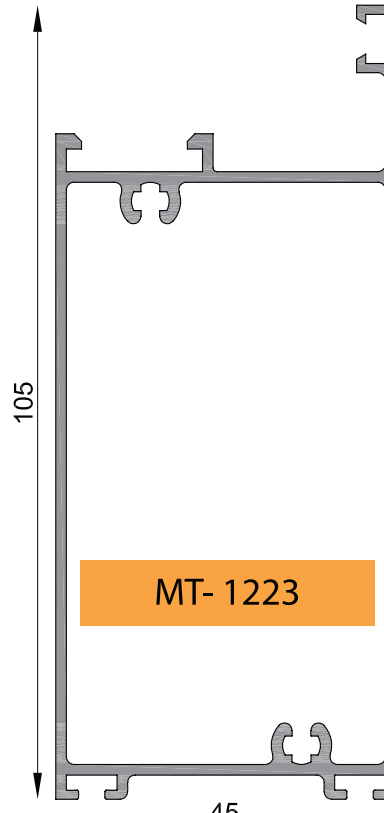

MT- 1223

Zócalo puerta
Peso estimado: 1.280 Kg/m
Largo STD: 6030 mm

Jamba
Peso estimado: 1.185 Kg/m
Largo STD: 6030 mm

MT- 0230

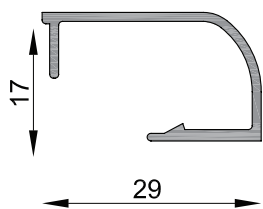

Contra vidrio curvo 29 mm
Peso estimado: 0.213 Kg/m
Largo STD: 6030 mm

MT- 1272

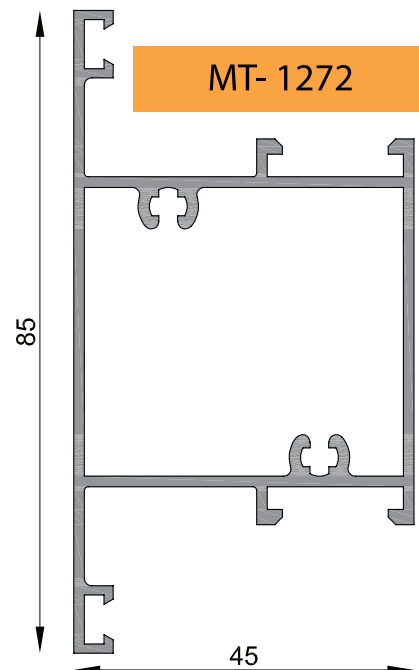

Travesaño puerta
Peso estimado: 1.085 Kg/m
Largo STD: 6030 mm

MT- 0202

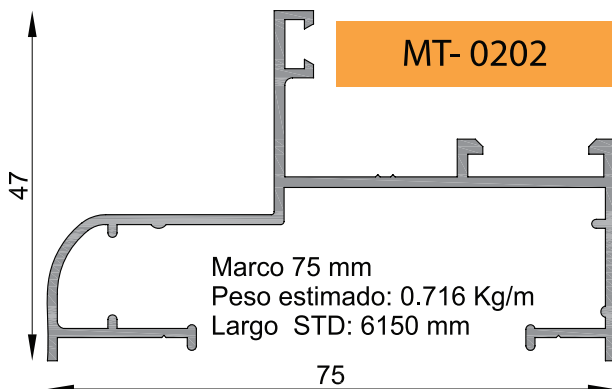

ACOPLES

MT- 0213

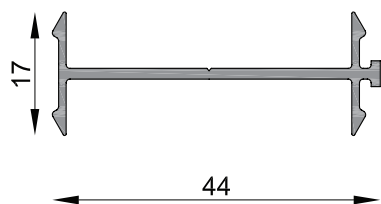

Perfil de acople plano
Peso estimado: 0.257 Kg/m
Largo STD: 6030 mm

MT- 0265

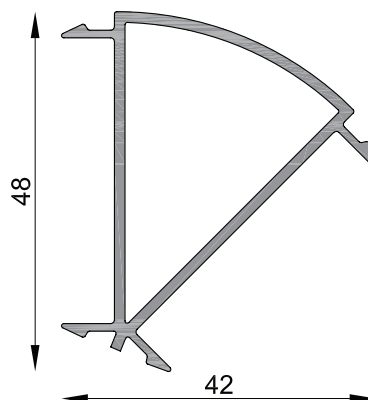

Columna acople 135°
Peso estimado: 0.535 Kg/m
Largo STD: 6150 mm

MT- 0261

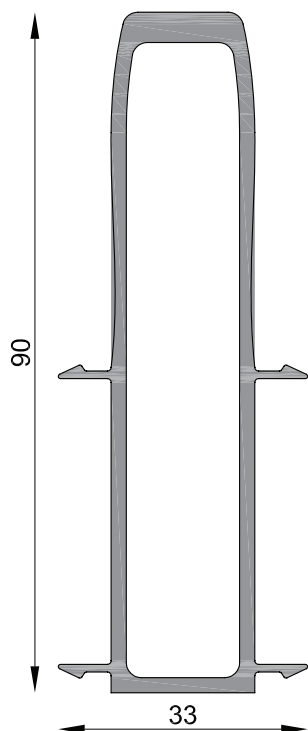

Columna de acople reforzada
Peso estimado: 1.274 Kg/m
Largo STD: 6150 mm

MT- 0262

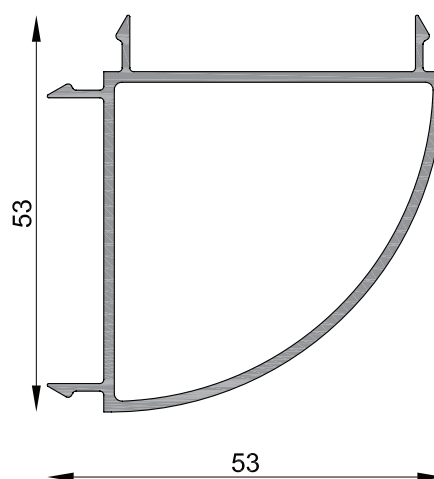

Perfil de acople a 90°
Peso estimado: 0.680 Kg/m
Largo STD: 6150 mm

BARANDA PANORAMA

MT- 4503

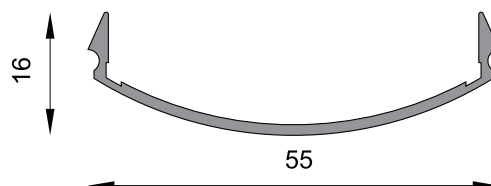

Tapa inferior pasamanos
 Peso estimado: 0.267 Kg/m
 Largo STD: 6030 mm

MT- 4514

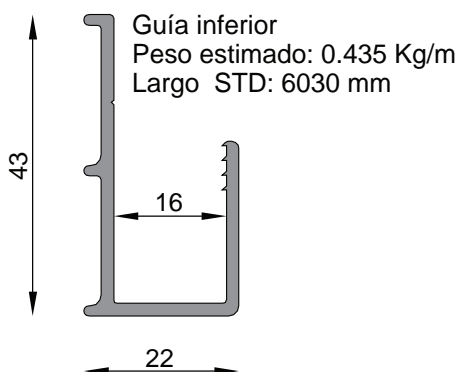

Guía inferior
 Peso estimado: 0.435 Kg/m
 Largo STD: 6030 mm

MT- 4502

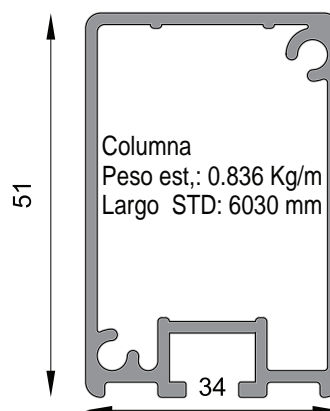

Columna
 Peso est.: 0.836 Kg/m
 Largo STD: 6030 mm

MT- 1305

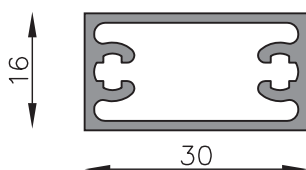

Parante baranda 30 mm.
 Peso estimado: 0.424 Kg/m
 Largo STD: 6030 mm

MT- 4509

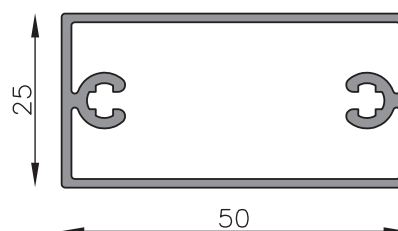

Parante
 Peso estimado: 0.662 Kg/m
 Largo STD: 6030 mm

BARANDA BALCON

PASAMANOS

MT- 4512

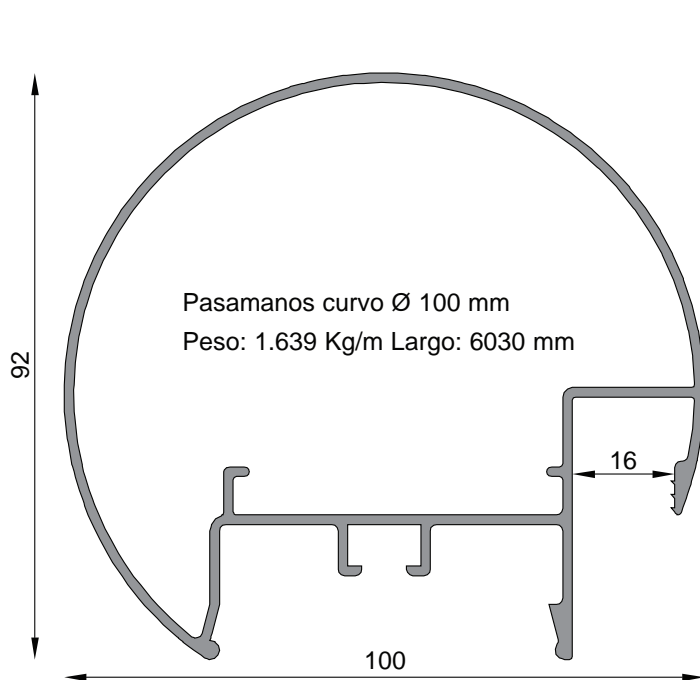

MT- 4510

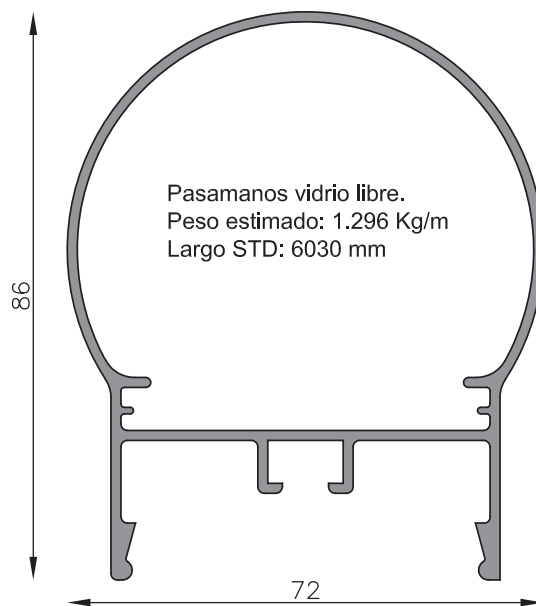

MT- 0909

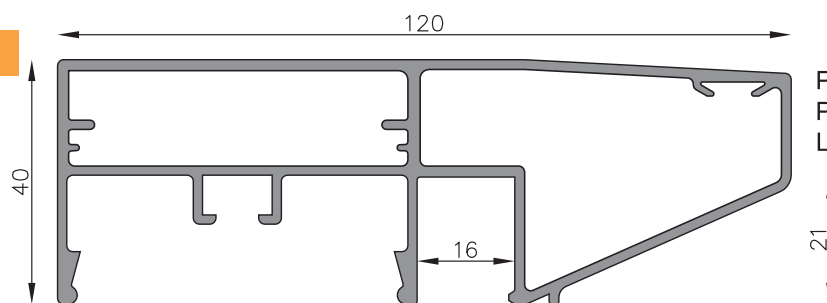

Pasamanos recto de 120mm
Peso estimado: 1.812 Kg/m
Largo STD: 6030 mm

MT- 4513

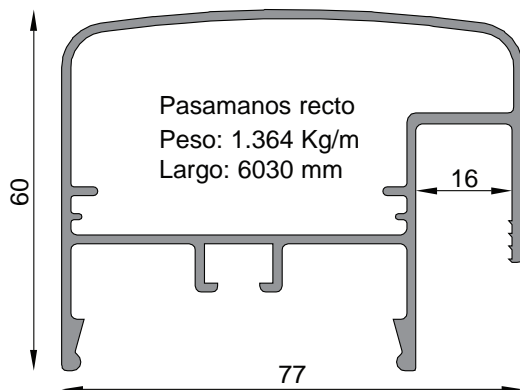

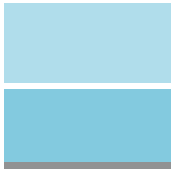

BARANDA
HORIZONTE



Baranda Horizonte



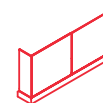

Características técnicas:

- ▶ La transparencia del vidrio proporciona a los espacios una conexión visual con el exterior.
- ▶ El sistema utiliza vidrios templados y laminados de 16,76 mm hasta 21,52 mm de espesor.
- ▶ Admite 8 posibilidades de conformación (Ver tabla de vidrios templados, lámina central y calzos).
- ▶ Posibilidad de montaje sobre losa o piso de hormigón calidad H20 o H21 terminado según corresponda.
- ▶ Fácil instalación desde el interior con presor para asegurar la sujeción del vidrio.
- ▶ Ancho máximo del módulo 1.000 mm.
- ▶ Altura máxima 1.100 mm.
- ▶ Peso máximo de 44 Kg para cada módulo de vidrio de 8+8 mm.
- ▶ Peso máximo de 55 Kg para cada módulo de vidrio de 10+10 mm.

▶ El sistema de Baranda Horizonte fue desarrollado tomando en cuenta la norma de referencia europea UNE-85237:1991, UNE-85.238:1991 y UNE-85240:1990, requisitos establecidos de protocolos para categorías de uso de hasta 100 kg/m y 300 kg/m lineal de esfuerzo.

- 1 - Ensayo estático de flexión con fuerza horizontal hacia el exterior.
- 2 - Ensayo estático de flexión con fuerza horizontal hacia el interior.
- 3 - Ensayo estático de flexión con fuerza incrementada horizontal hacia el exterior.
- 4 - Ensayo estático de flexión con fuerza vertical hacia abajo.
- 5 - Ensayo dinámico con cuerpo blando.
- 6 - Ensayo dinámico con cuerpo duro.

▶ Barandas Horizonte ensayadas por MDT ARGENTINA en el INTI.

▶ El sistema de baranda Horizonte ha sido testado de forma exigente para garantizar la máxima seguridad cumpliendo para uso:

- ⊕ Privado con 80 Kg/m
- ⊕ Público con 160 Kg/m
- ⊕ Grandes aglomeraciones con 300 Kg/m.

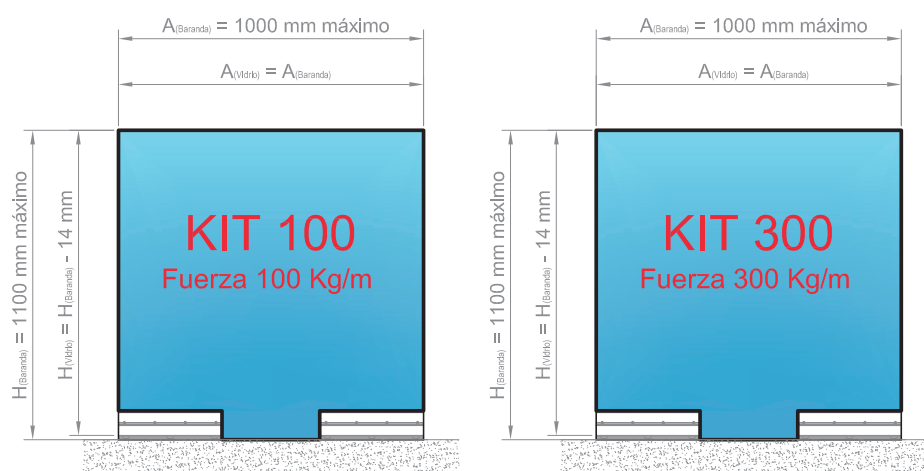

Baranda Horizonte KIT 300 - Vista en explosión

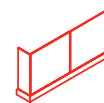

Despiece KIT 300

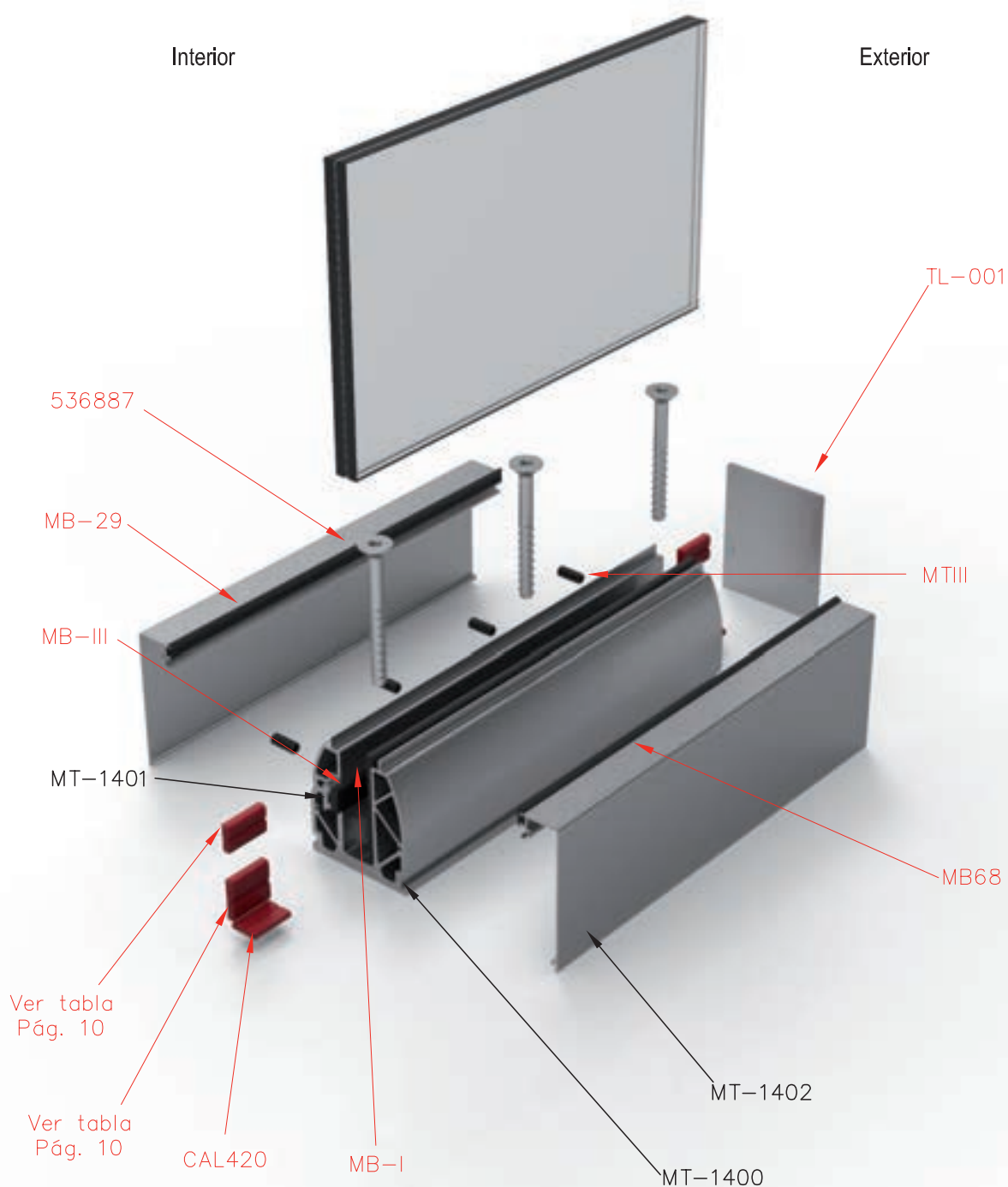



Baranda Horizonte - Pasamanos

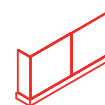

Colocación de espina elástica

- ① Coloque las espinas elásticas en su posición dentro del perfil MT-1403
- ② Clave la espina elástica hasta introducir la mitad dentro del perfil.
- ③ Coloque el perfil MT-1403 siguiente en las espinas elásticas para su guiado, una los dos perfiles. De ser necesario realice unos golpes con maza de goma en el extremo del segundo perfil.

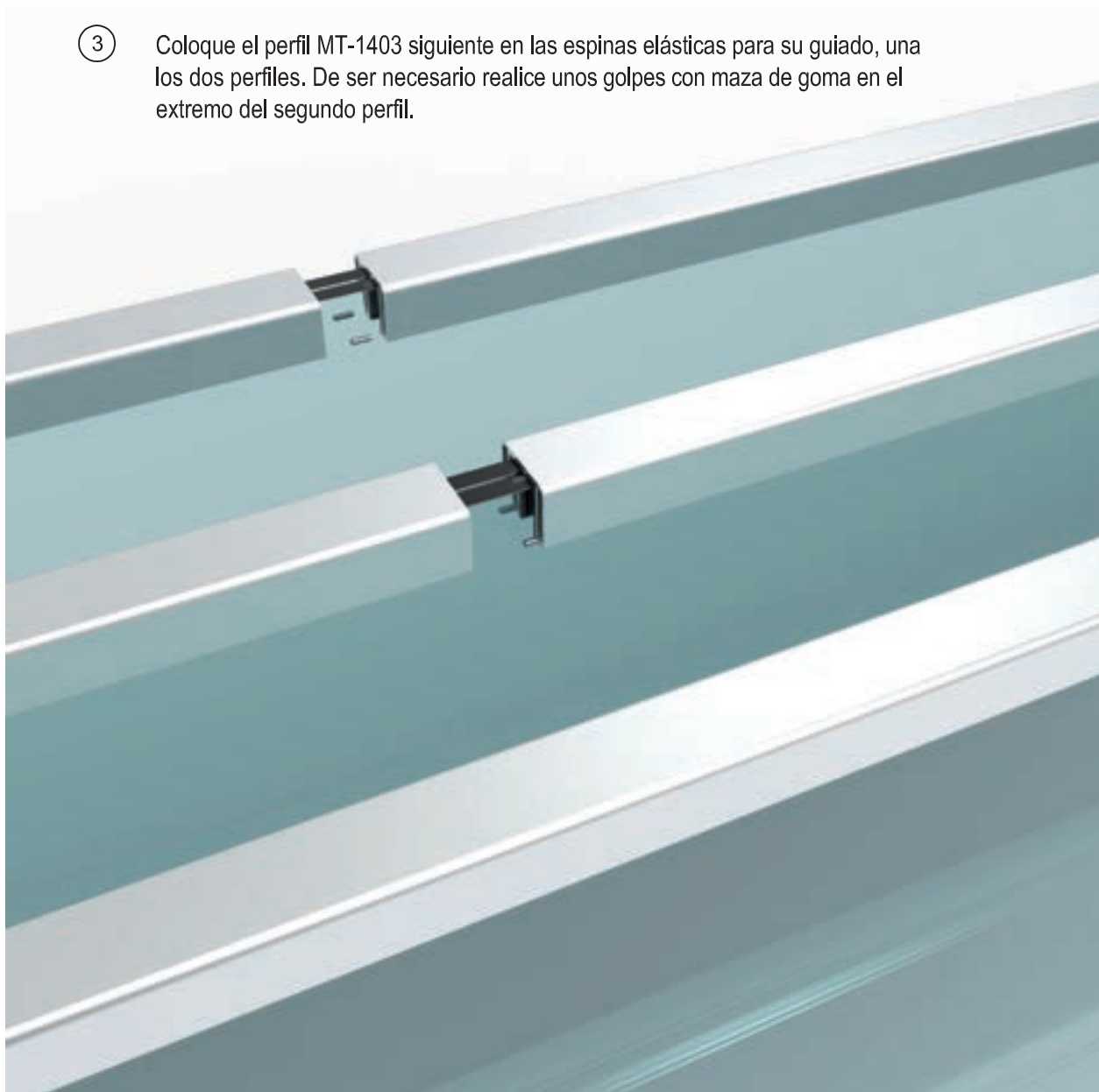

Nota: Para colocar las espinas elásticas no se precisa repasar el agujero.

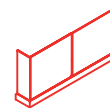

ESQUEMA B

Esquema de colocación múltiple a 90°

Terminación de esquinas

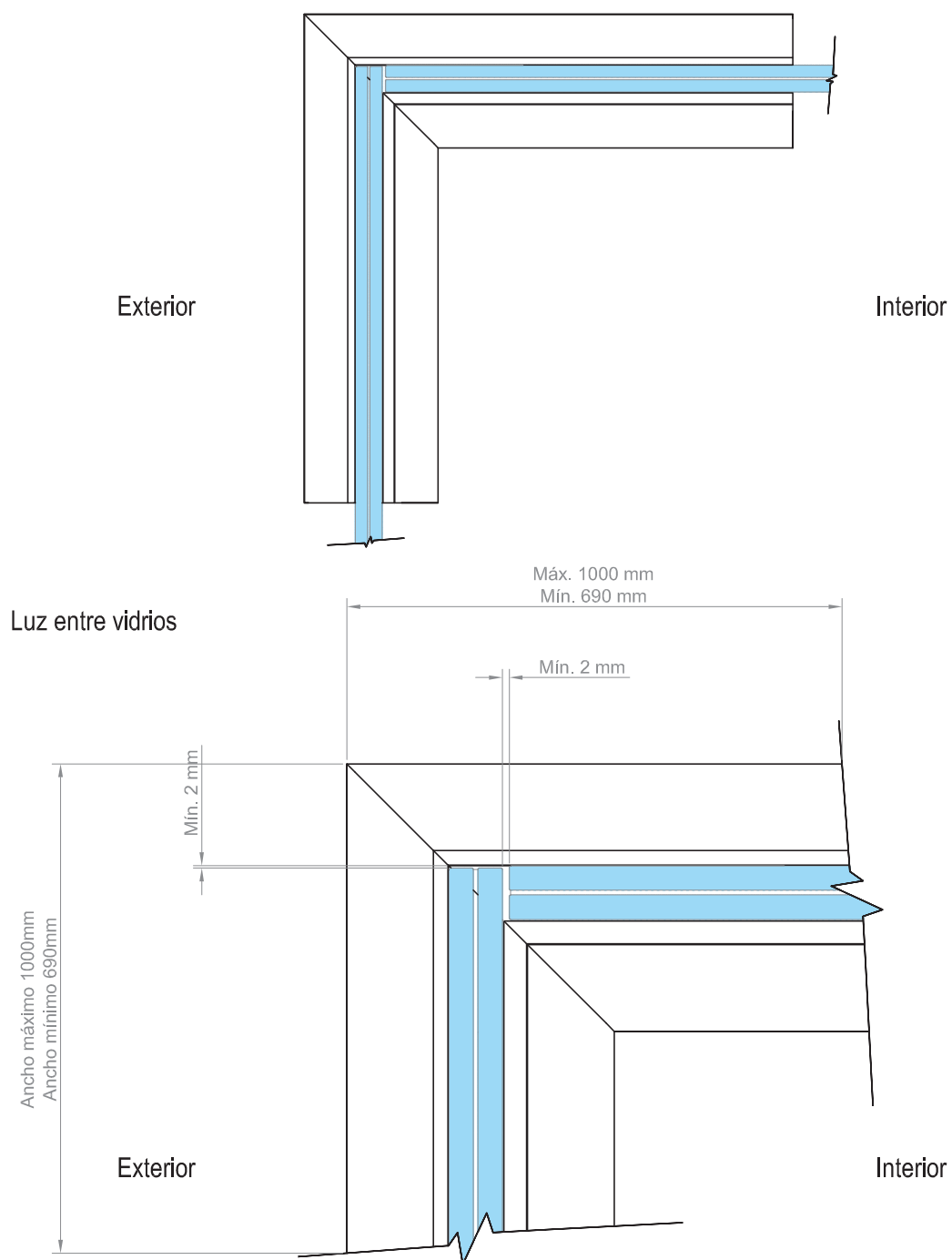

FRENTE INTEGRAL

FRENTE INTEGRAL

MT- 0818

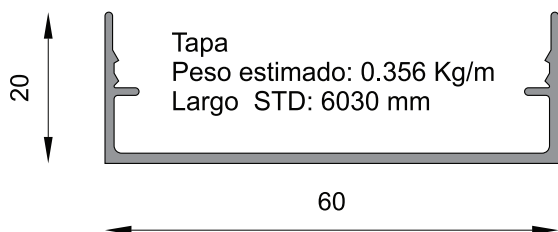

MT- 0819

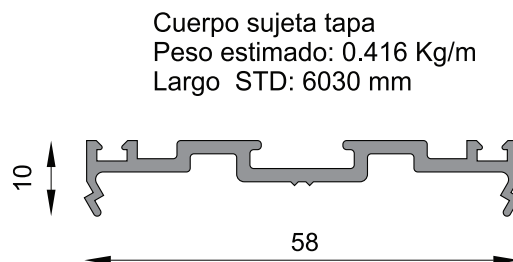

MT- 0997

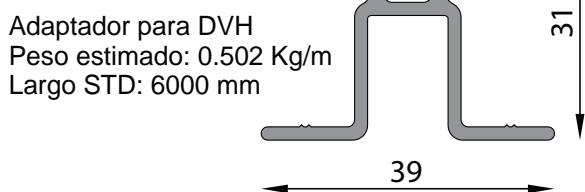

MT- 2776

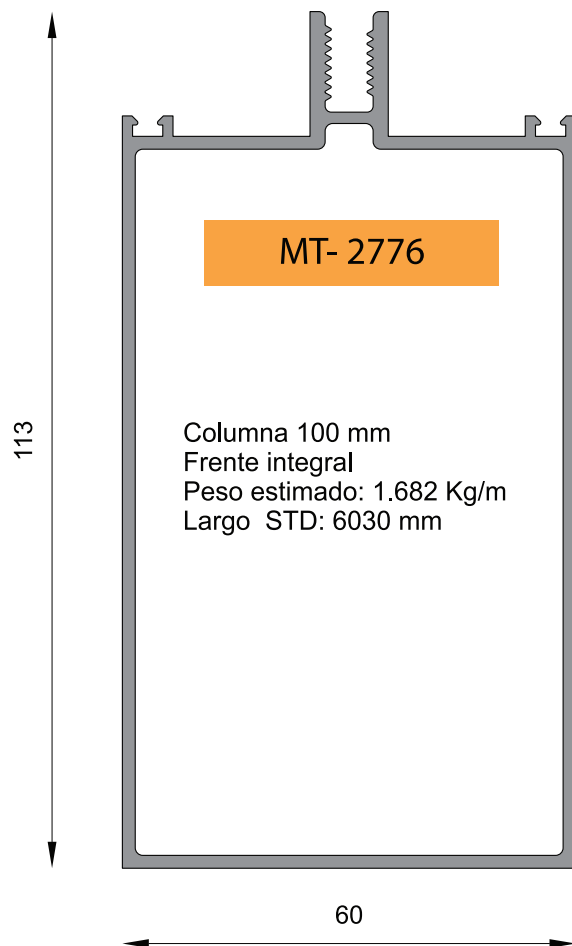

MT- 0816

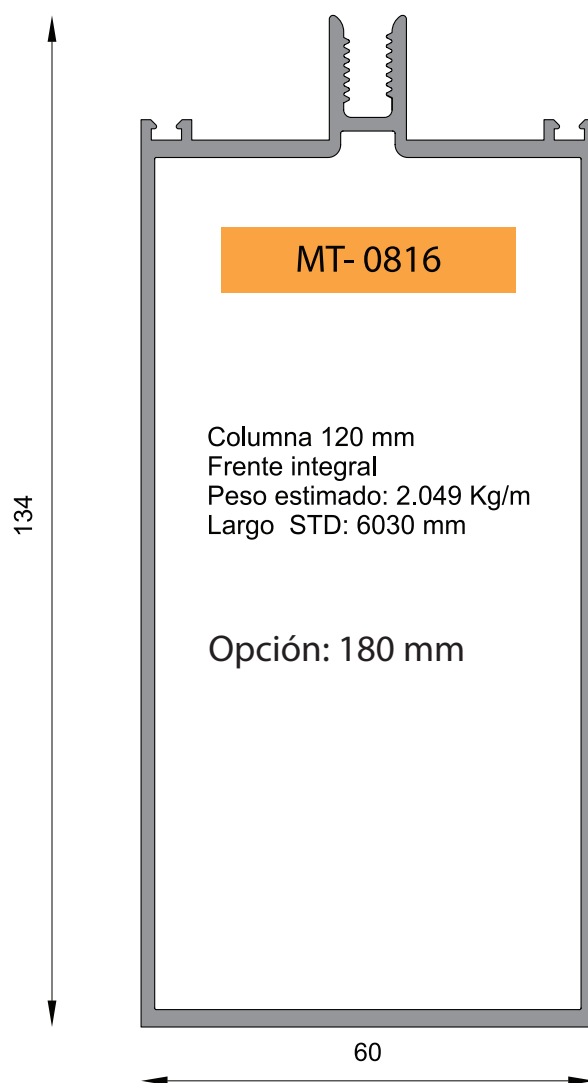

FRENTE INTEGRAL

FRENTE INTEGRAL

MT- 0820

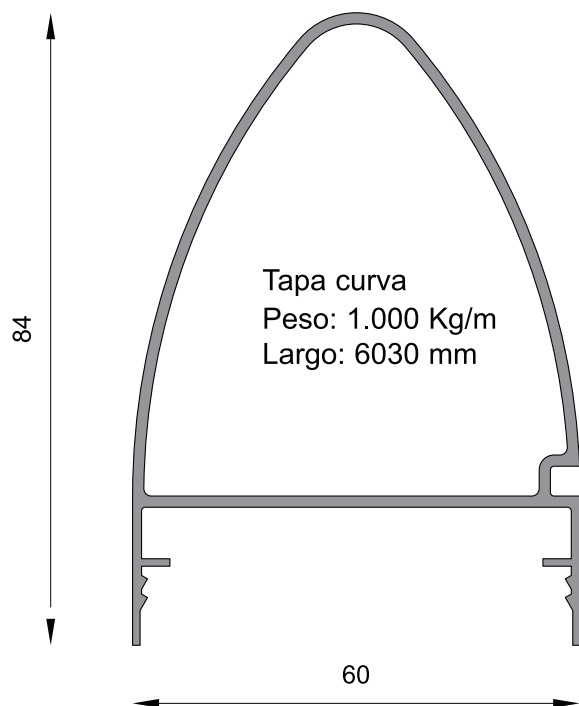

MT- 0817

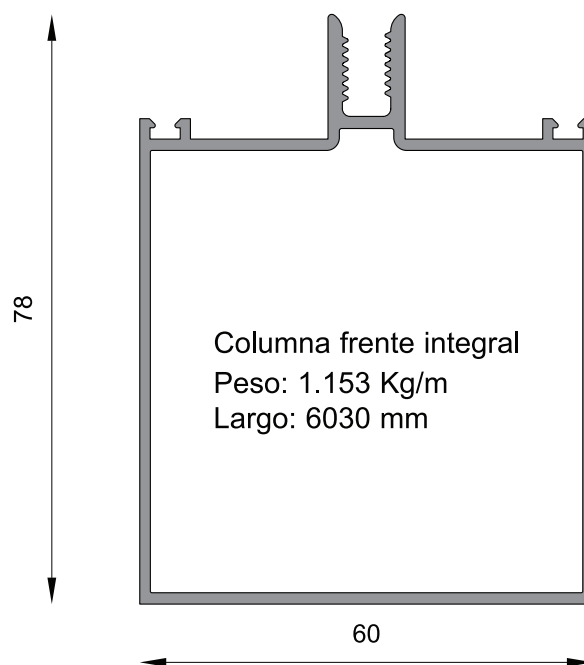

Para mas información ingresar a www.aluminiopanamericana.com.ar

LISTADO CODIGO A30

6034	
6035	
6036	
6037	
6038	
6039	
6040	
6041	
6042	
6043	
6044	
6045	
6046	
6047	
6048	
6049	
6051	
6052	
6054	
6055	
6056	



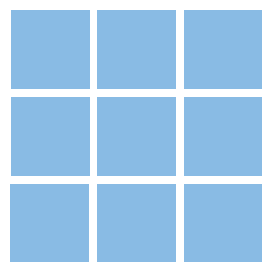
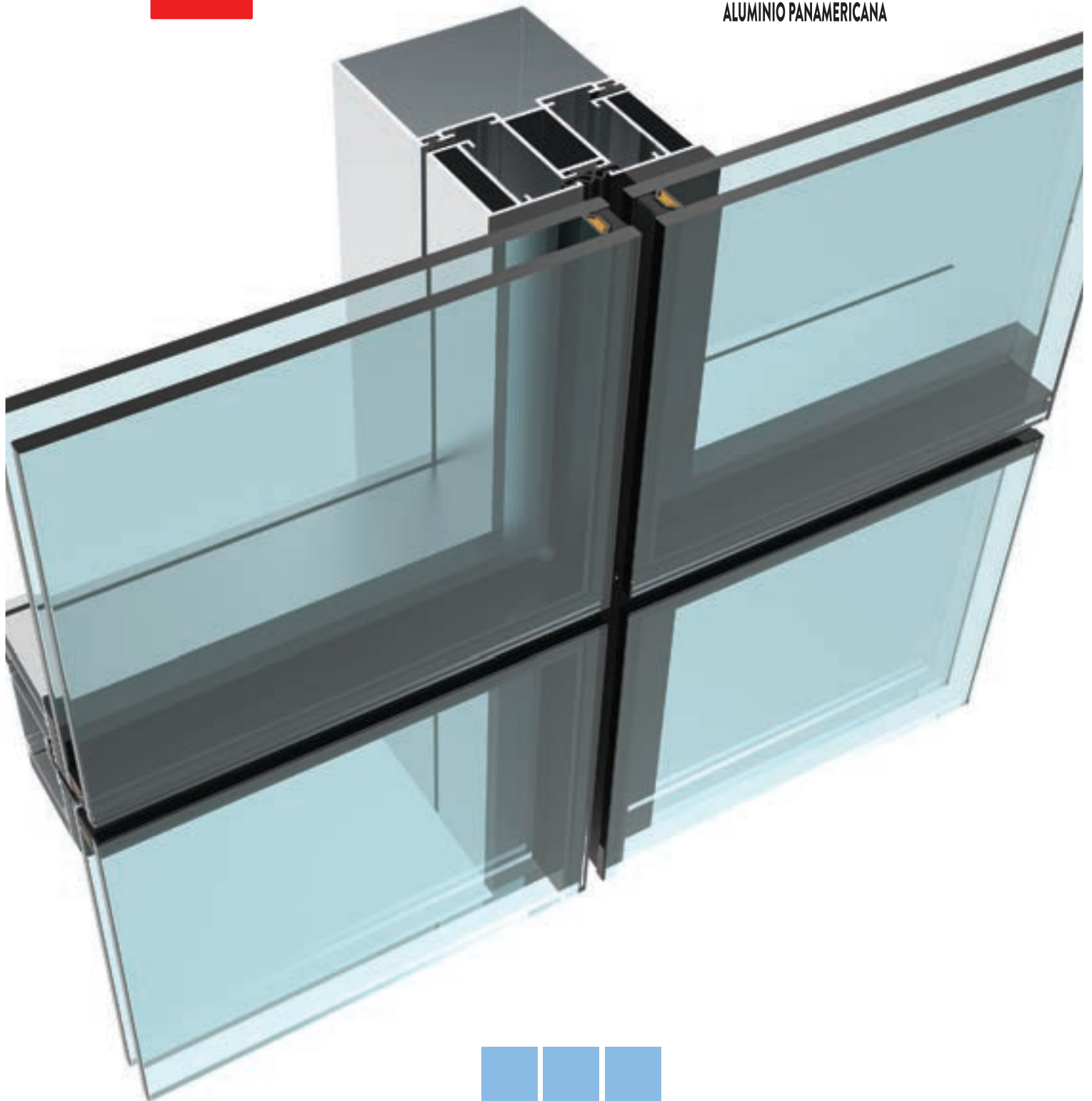





















6057	
6058	
6059	
6060	
6061	
6062	
6066	
6067	
6069	
6070	
6071	
6072	
6073	
6074	
6078	
6079	
6080	
6081	
6082	
6083	
6084	



PIEL DE VIDRIO



















Listado de Perfiles

CÓDIGO	PESO (kg/m)	DESCRIPCIÓN	FORMA
MT-0833	2.935	Refuerzo para columna suplementaria	
MT-5085	0.254	Tapa de perfil MT-5250	
MT-5138	3.596	Columna suplementaria	
MT-5202	1.785	Columna 97mm	
MT-5208	0.783	Parante de hoja	
MT-5222	0.786	Bota agua	
MT-5223	0.832	Bota agua	
MT-5224	0.810	Bota agua - DVH	
MT-5225	0.645	Marco perimetral	
MT-5226	0.745	Bota agua	
MT-5227	0.672	Bota agua paño fijo	
MT-5228	0.594	Travesaño hoja vidriado estructural	
MT-5231	1.058	Columna divisoria	
MT-5232	1.299	Columna 57mm	
MT-5239	0.375	Tapa de columna	
MT-5241	1.801	Columna a 45°	
MT-5242	0.788	Tapa columna	
MT-5243	1.083	Media columna	
MT-5244	1.779	Columna a 90°	
MT-5246	0.761	Remate zócalo y cieloraso	
MT-5247	0.443	Remate zócalo y cieloraso	
MT-5249	0.602	Bota agua paño de abrir - vidriado estructural	
MT-5250	0.848	Revestimiento de zócalo	
MT-5256	0.408	Cierre perimetral	



Listado de Perfiles

CÓDIGO	PESO (kg/m)	DESCRIPCIÓN	FORMA
MT-5258	0.486	Remate de canto	
MT-5259	1.058	Columna lateral	
MT-5260	0.656	Tapa columna	
MT-5261	0.554	Parante hoja	
MT-5293	0.678	Travesaño horizontal	
MT-5301	0.111	Contravidrio	
MT-5325	1.224	Media columna hembra	
MT-5326	1.051	Macho Columna	
MT-5516	0.683	Travesaño - Parante de hoja	
MT-5565	0.151	Contravidrio DVH	
MT-5576	0.691	Hoja vidriado estructural - DVH	
MT-5588	0.459	Bota agua	
MT-5613	0.853	Bota agua	
MT-5614	2.649	Columna 140mm	
MT-5630	0.834	Hoja DVH con contravidrio	
MT-5816	0.656	Hoja DVH escalonado	
MT-5898	0.605	Hoja DVH en offset	

Para mas información ingresar a www.aluminiopanamericana.com.ar



Línea **Mass R60**



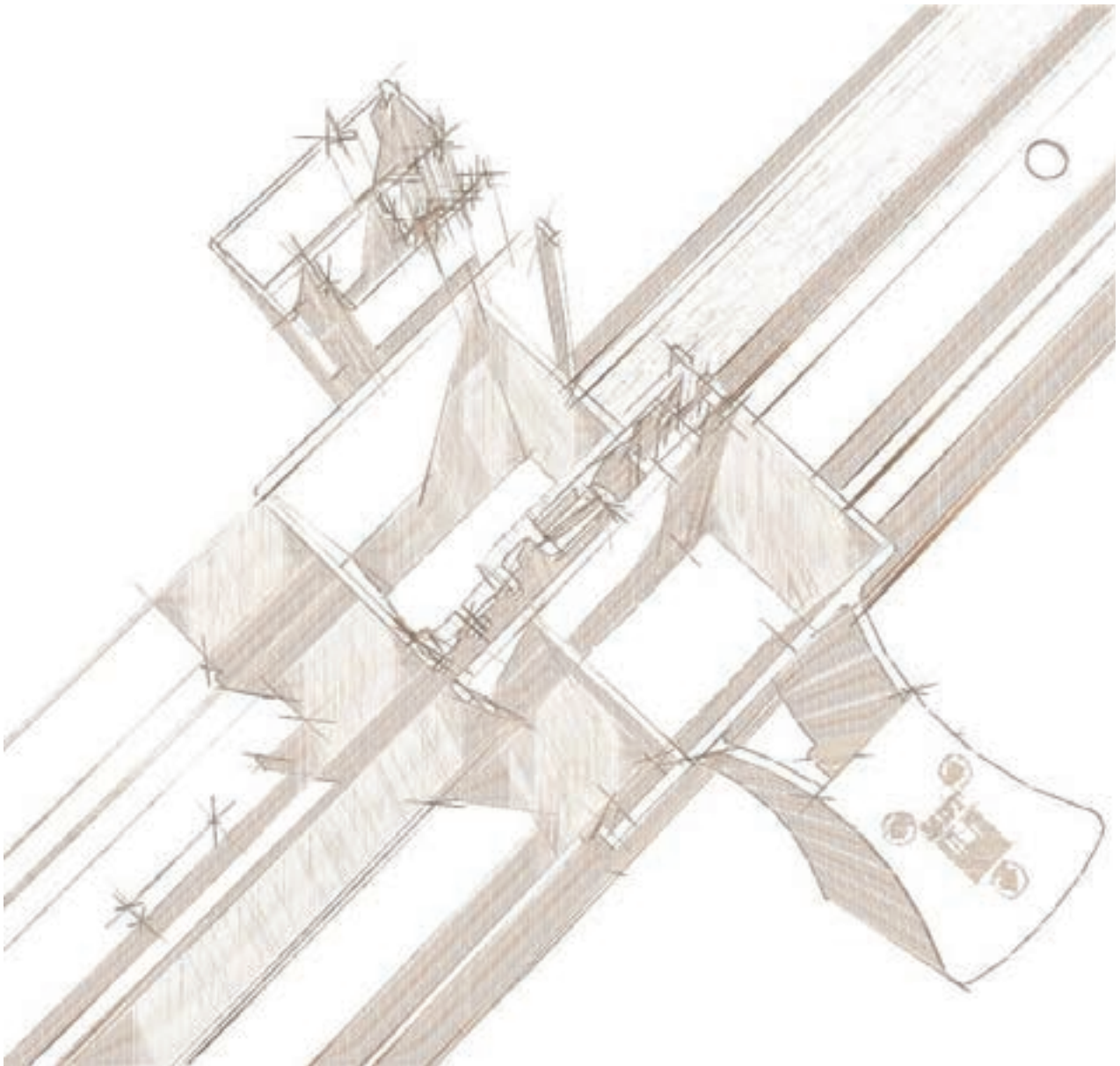







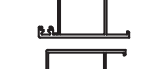

Catalogo General



Mass R60





























Listado de Perfiles

CÓDIGO	PESO (kg/m)	DESCRIPCIÓN	FORMA
MT-6501	0.848	Cabezal - Zócalo corte a 90°	
MT-6502	1.396	Zócalo alto corte a 90°	
MT-6503	1.226	Parante lateral de hoja corte a 90°	
MT-6504	1.204	Parante central de hoja corte a 90°	
MT-6505	0.316	Tope mosquitero corte a 90°	
MT-6506	3.175	Parante super reforzado corte a 90°	
MT-6507	1.631	Parante central reforzado corte a 90°	
MT-6508	0.286	Adaptador VS corte a 90°	
MT-6510	1.274	Jambas de tres guías corte a 90°	
MT-6511	0.797	Jambas de marco corte a 90°	
MT-6512	1.630	Umbral - Dintel de marco corte a 90°	
MT-6513	0.085	Guía de marco corte a 90°	
MT-6514	0.286	Encuentro central para cuatro hojas corte a 90°	
MT-6515	2.314	Umbral y dintel de marco de tres guías corte a 90°	
MT-6516	0.867	Premarco para corrediza de 3 guías corte a 90°	
MT-6517	0.532	Premarco	
MT-6520	0.948	Marco para paño fijo	
MT-6521	1.094	Travesaño para paño fijo	
MT-6522	0.970	Marco para ventana de abrir	
MT-6523	1.240	Marco para puerta de rebatir	
MT-6524	0.835	Marco para ventana desplazable	
MT-6526	1.037	Hoja para ventana de abrir	
MT-6528	1.380	Hoja para puerta de rebatir	
MT-6529	1.508	Travesaño para puerta de rebatir	
MT-6530	2.395	Zócalo para puerta de rebatir	
MT-6531	1.026	Encuentro central para ventana de abrir	





Listado de Perfiles

CÓDIGO	PESO (kg/m)	DESCRIPCIÓN	FORMA
MT-6532	1.373	Hoja para ventana desplazable	
MT-6533	0.204	Contravidrio recto exterior de puerta	
MT-6534	0.368	Contravidrio recto interior 40mm	
MT-6535	0.166	Contravidrio recto interior 15mm corte 45°	
MT-6536	0.481	Acople a 180° módulo 60mm a 3 guías corte a 90°	
MT-6537	1.472	Marco de dos guías 45° Recto	
MT-6538	2.157	Marco de tres guías 45° Recto	
MT-0206	0.184	Tapa junta	
MT-0212	0.315	Contravidrio recto interior 36mm	
MT-0217	0.292	Contravidrio recto interior 29mm	
MT-0225	0.257	Contravidrio recto interior 22mm	
MT-0226	0.210	Contravidrio recto interior 15mm	
MT-0230	0.213	Contravidrio curvo interior 29mm	
MT-0231	0.159	Contravidrio curvo interior 15mm	
MT-0232	0.181	Contravidrio curvo interior 22mm	
MT-0233	0.135	Contravidrio curvo interior 8mm	
MT-0238	0.183	Contravidrio recto interior 8mm	
MT-0245	0.623	Tapa cinta	
MT-0255	0.389	Hoja para mosquitero	
MT-0256	0.446	Travesaño para mosquitero	
MT-0257	0.235	Contravidrio curvo interior 36mm	
MT-0326	0.617	Hoja para mosquitero reforzado	
MT-0351	0.300	Acople 180°, módulo 60 a 45mm	
MT-0379	1.102	Refuerzo parante central corte a 45°	
MT-0390	0.915	Premarco para corrediza de 3 guías corte a 45°	
MT-0394	0.817	Caja de agua auxiliar	



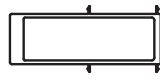



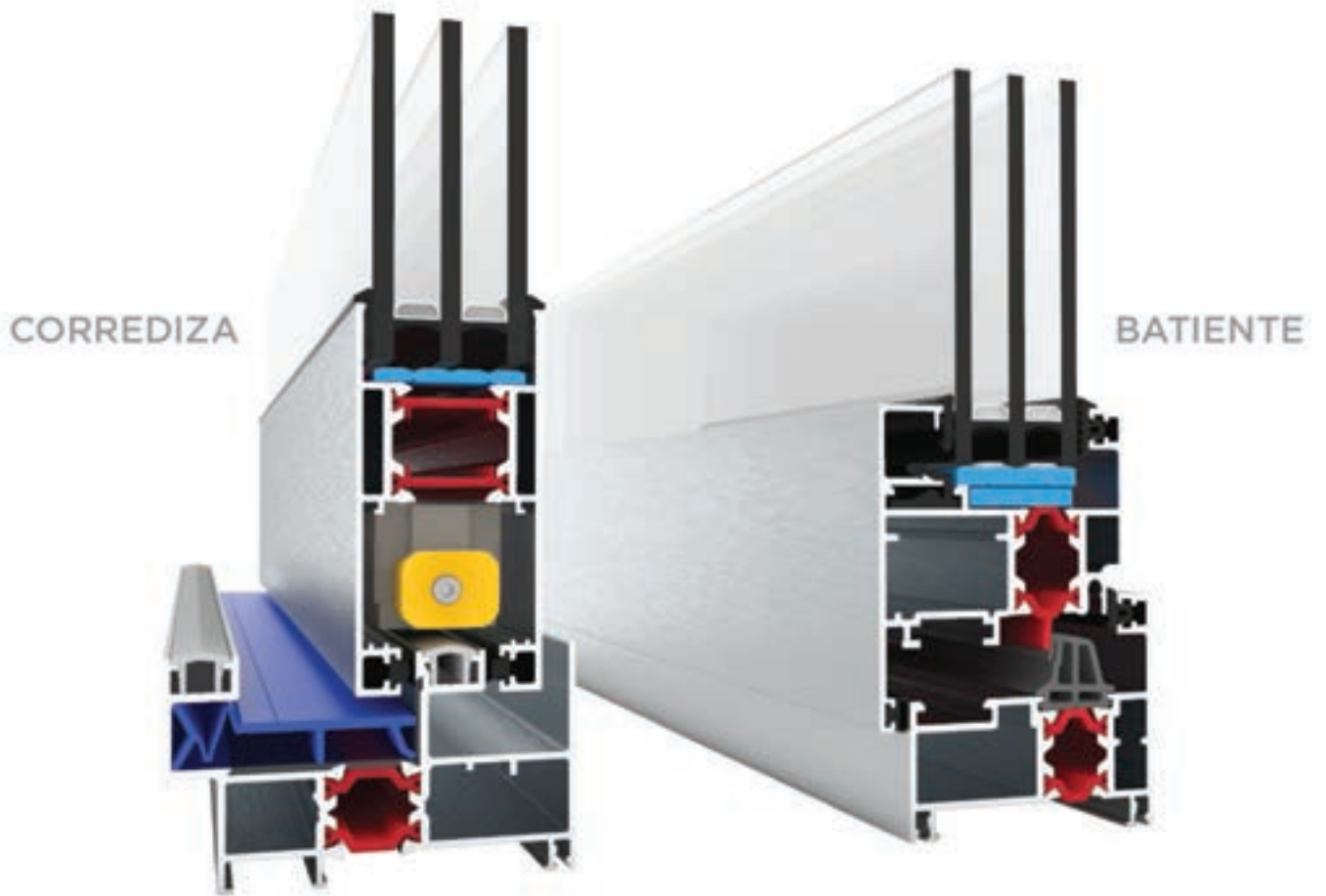







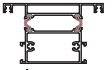

Listado de Perfiles

CÓDIGO	PESO (kg/m)	DESCRIPCIÓN	FORMA
MT-0397	1.370	Hoja ventana corrediza DVH (luz 30 mm)	
MT-0401	0.343	Acople a 180°, módulo de 60mm	
MT-0402	0.429	Solapa central 45° para MT-0397	
MT-0412	3.494	Acople reforzado a 180° módulo de 60mm - Columna	
MT-0415	0.200	Tapa junta recto	
MT-0534	1.053	Refuerzo parante central corte a 90°	
MT-0615	0.246	Adaptador VS 45° Recta	
MT-0619	1.118	Hoja ventana corrediza DVH (luz 30 mm)	
MT-0621	0.405	Solapa central 45° para MT-0619	
MT-3202	0.348	Tapa junta curvo	
MT-4001	1.380	Hoja corrediza DVH 22mm corte a 45°	
MT-4007	0.473	Encuentro central para 4 hojas corte a 45°	
MT-4010	1.488	Hoja corrediza VS luz 12mm corte a 45°	
MT-4020	0.964	Encuentro central para puerta de rebatir	
MT-4024	0.946	Acople a 90°, módulo de 60mm	
MT-4025	0.722	Acople a 135°, módulo de 60mm	
MT-4026	0.681	Acople a 180°, módulo de 60mm a 3 guías corte 45°	
MT-4028	0.340	Bisagra tapa cinta	
MT-4029	0.713	Guía para cortina	
MT-6090	0.159	Pletina	
MT-6151	0.732	Hoja para mosquitero súper reforzado corte a 45°	

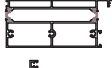

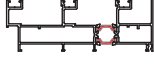

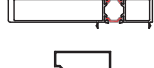
Listado de Perfiles Ensamblados

CÓDIGO Ensamble	PESO (kg/m) Al + PA25%FV	DESCRIPCIÓN	FORMA
MRPT-001	1.337	Marco para paño fijo	
MRPT-002	1.304	Marco para ventana batiente	
MRPT-003	1.223	Marco para ventana desplazable	
MRPT-004	1.412	Travesaño para paño fijo	
MRPT-005	2.228	Travesaño para puerta batiente	
MRPT-006	1.223	Encuentro central para VR Y PR	
MRPT-007	1.414	Hoja para ventana batiente	
MRPT-008	1.850	Hoja para puerta batiente	
MRPT-009	3.302	Zócalo para puerta batiente	
MRPT-010	1.677	Hoja para ventana desplazable	
MRPT-011	1.720	Marco corredizo de dos guías	
MRPT-012	2.403	Marco corredizo de tres guías	
MRPT-013	1.489	Hoja corrediza DVH hasta 32mm	
MRPT-014	2.168	Acople reforzado	
MRPT-015	2.041	Acople a 90°	



Listado de Perfiles

CÓDIGO	PESO (kg/m)	DESCRIPCIÓN	FORMA
MT-0206	0.184	Tapa junta	
MT-0217	0.292	Contra vidrio recto interior 29mm	
MT-0225	0.257	Contra vidrio recto interior 22mm	
MT-0226	0.210	Contra vidrio recto interior 15mm	
MT-0230	0.213	Contra vidrio curvo interior 29mm	
MT-0231	0.159	Contra vidrio curvo interior 15mm	
MT-0232	0.181	Contra vidrio curvo interior 22mm	
MT-0233	0.135	Contra vidrio curvo interior 8mm	
MT-0238	0.183	Contra vidrio recto interior 8mm	
MT-0542	0.597	Hoja mosquitero	
MT-0543	0.154	Solapa mosquitero	
MT-6090	0.159	Pletina	
MT-6323	0.462	Guía mosquitero	
MT-6324	1.137	Refuerzo de parante central	
MT-6325	0.437	Umbral para puerta batiente	
MT-6326	0.167	Solapa de hoja para puerta batiente	
MT-6329	0.170	Tapa junta	
MT-6330	0.122	Acople a 180°	
MT-6336	0.575	Solapa central mas aislante	
MT-6337	0.270	Gotero para corrediza	
MT-6513	0.085	Guía de marco	
MT-6517	0.532	Premarco	
MT-6518	0.103	Pletina Roto Frank en Aluminio	
MT-6535	0.166	Contra vidrio recto interior 15mm	

Perfiles ensamblados

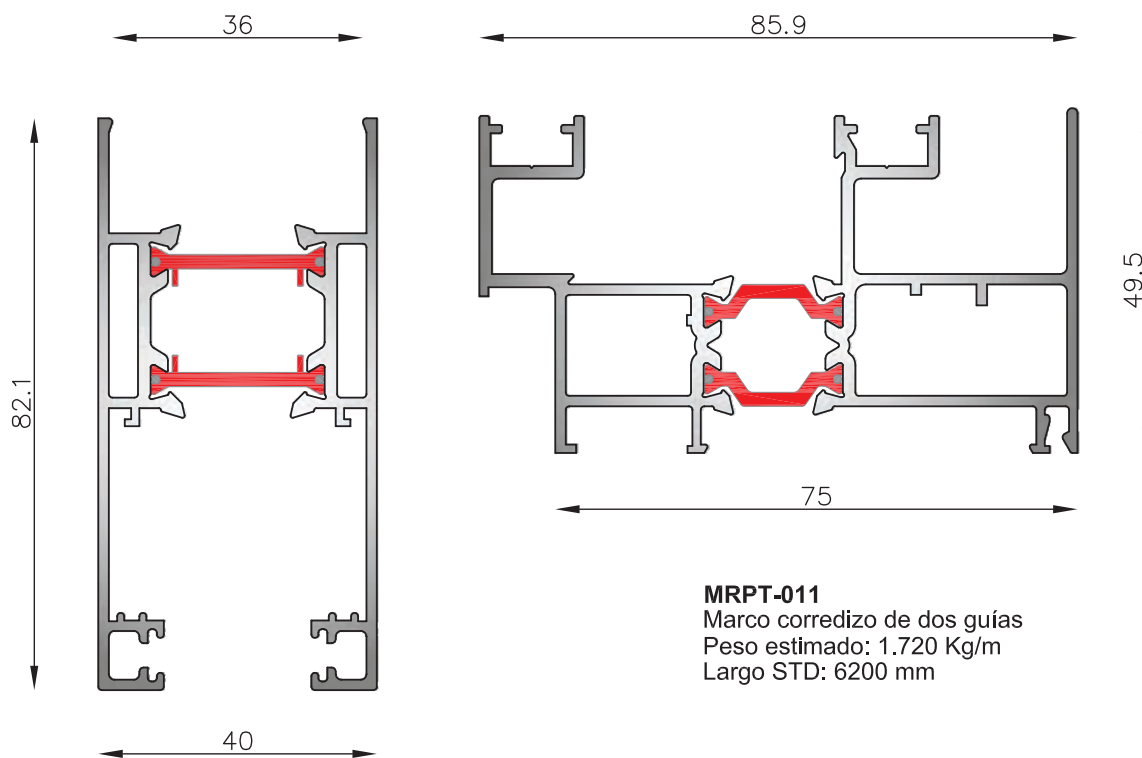

MRPT-011
Marco corredizo de dos guías
Peso estimado: 1.720 Kg/m
Largo STD: 6200 mm

MRPT-013
Hoja corrediza DVH hasta 32mm
Peso estimado: 1.489 Kg/m
Largo STD: 6200 mm

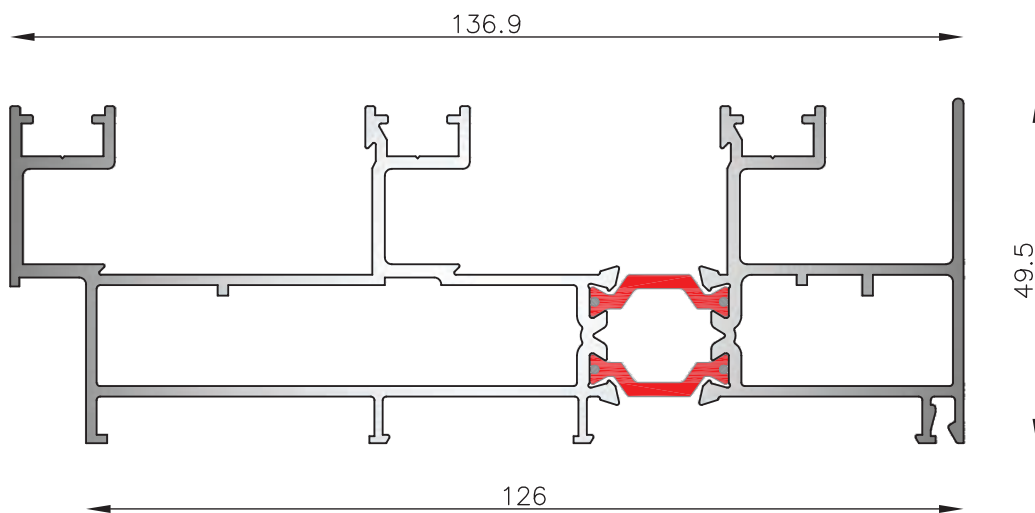

MRPT-012
Marco corredizo de tres guías
Peso estimado: 2.403 Kg/m
Largo STD: 6200 mm



Perfiles ensamblados

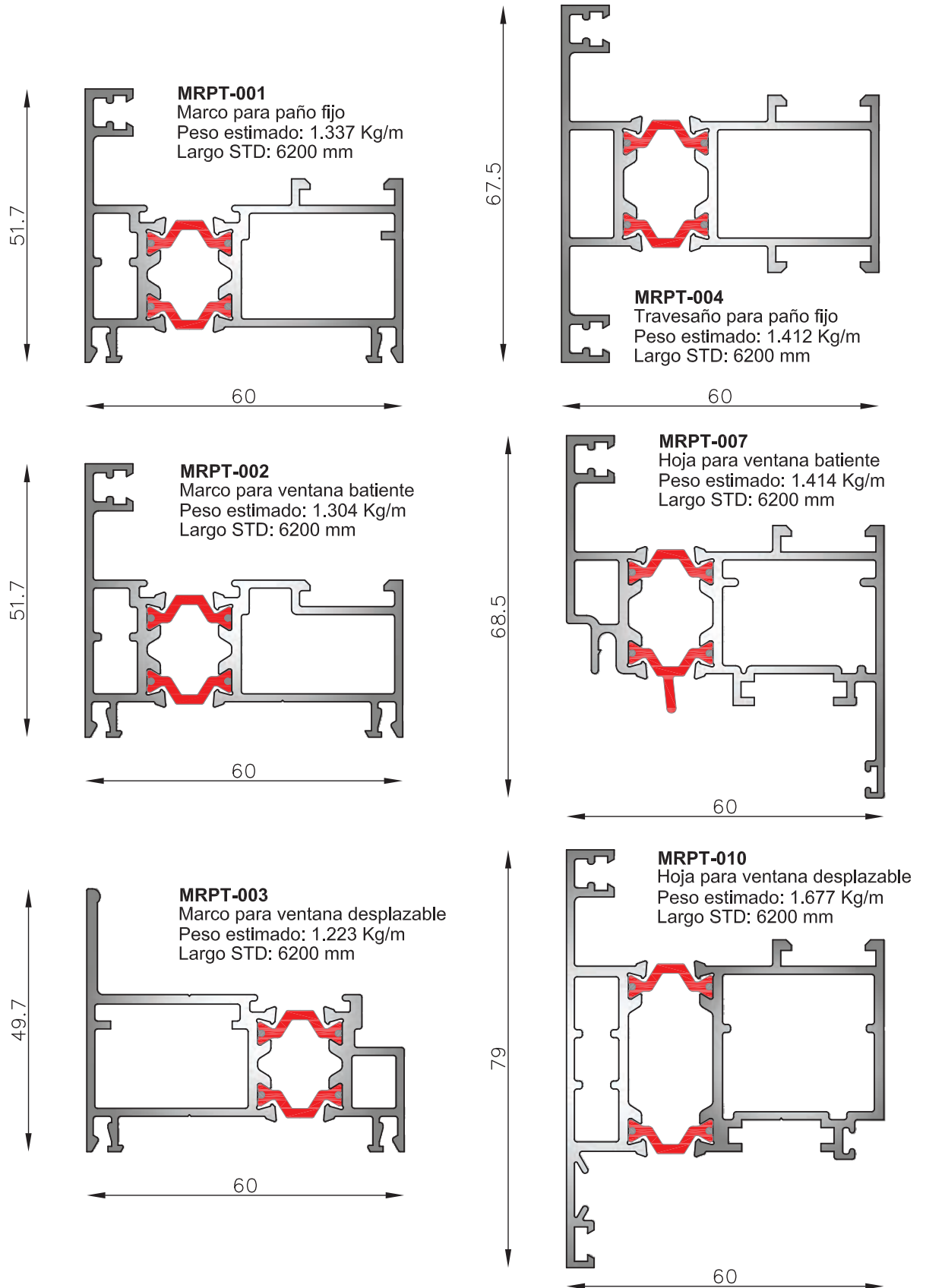



Perfiles ensamblados

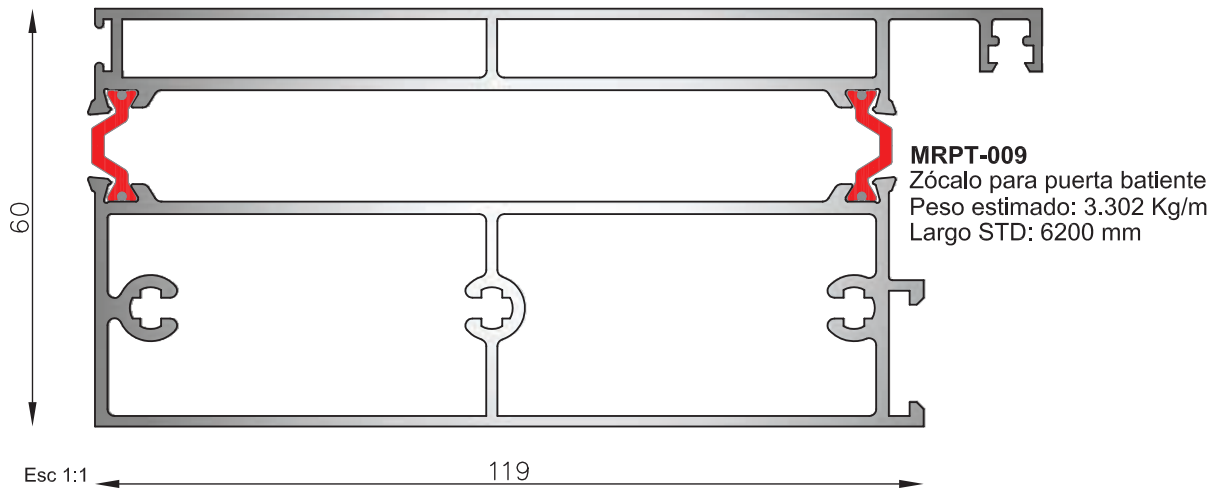
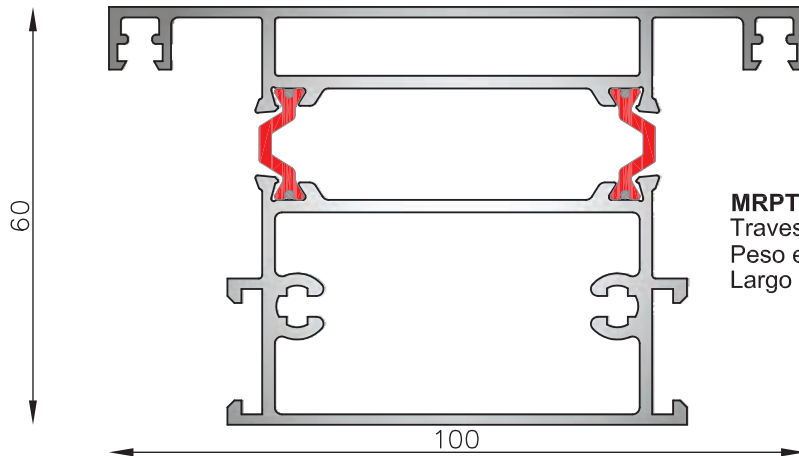
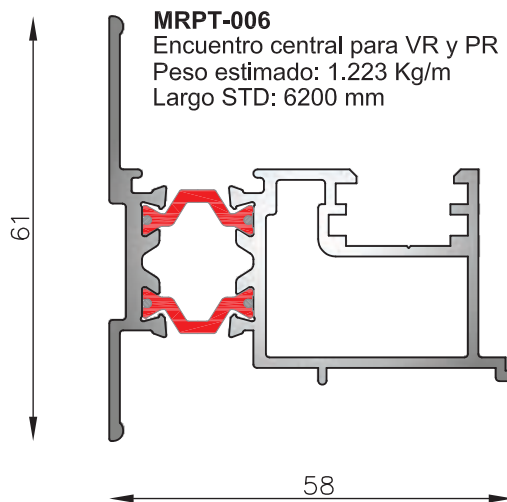
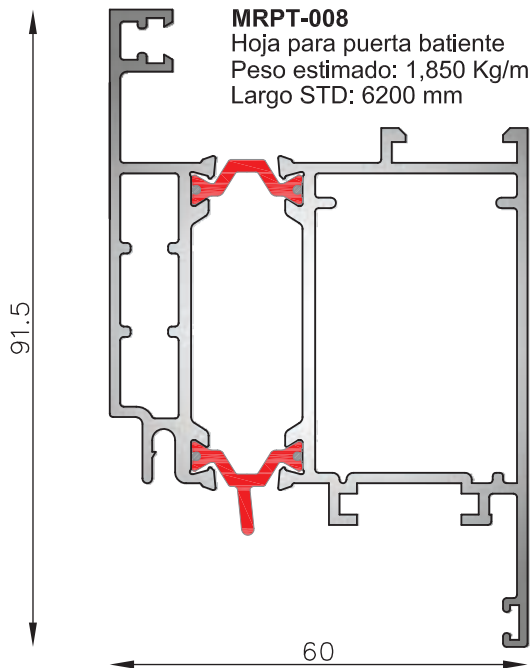



Perfiles ensamblados

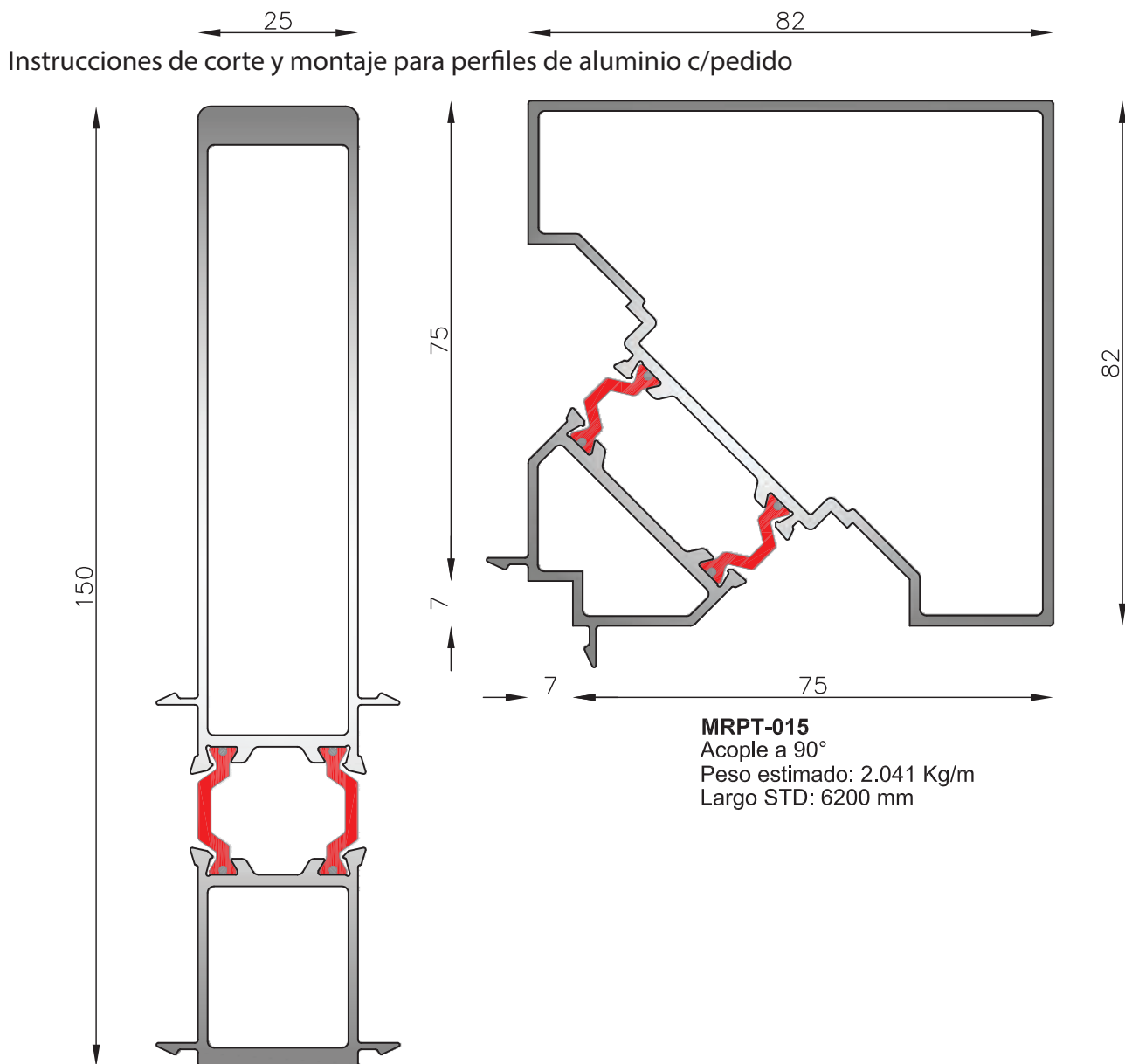

MRPT-014
 Acople Reforzado
 Peso estimado: 2.168 Kg/m
 Largo STD: 6200 mm



TECNOLOGÍA EN
ALUMINIO Y VIDRIO





















Mass R60 Plegable

Instrucciones de corte y montaje para perfiles de aluminio.





Listado de Perfiles

CÓDIGO	PESO (kg/m)	DESCRIPCIÓN	FORMA	PÁG.
MT-0212	0.315	Contravidrio recto interior 36mm		05
MT-0217	0.292	Contravidrio recto interior 29mm		05
MT-0225	0.257	Contravidrio recto interior 22mm		06
MT-0226	0.210	Contravidrio recto interior 15mm		06
MT-0230	0.213	Contravidrio curvo interior 29mm		07
MT-0231	0.159	Contravidrio curvo interior 15mm		07
MT-0232	0.181	Contravidrio curvo interior 22mm		07
MT-0233	0.135	Contravidrio curvo interior 8mm		07
MT-0238	0.183	Contravidrio recto interior 8mm		06
MT-0257	0.235	Contravidrio curvo interior 36mm		07
MT-0205	0.359	Premarco		04
MT-6528	1.380	Hoja para puerta de rebatir		04
MT-6529	1.508	Travesaño para puerta de rebatir		04
MT-6533	0.204	Contravidrio recto exterior de puerta		05
MT-6534	0.368	Contravidrio recto interior 40mm		05
MT-6535	0.166	Contravidrio recto interior 15mm corte 45°		05
MT-6557	1.542	Marco Perfil puerta plegable		04
MT-6090	0.159	Pletina		04



Mass R60 Osciloparalela

Instrucciones de montaje, mantenimiento y uso para perfiles de aluminio c/pedido



MT-0217	0.292	Contravidrio recto interior 29mm		5
MT-0225	0.257	Contravidrio recto interior 22mm		4
MT-0226	0.210	Contravidrio recto interior 15mm		6
MT-0230	0.213	Contravidrio curvo interior 29mm		7
MT-0231	0.159	Contravidrio curvo interior 15mm		7
MT-0232	0.181	Contravidrio curvo interior 22mm		7
MT-0233	0.135	Contravidrio curvo interior 8mm		7
MT-0238	0.183	Contravidrio recto interior 8mm		6
MT-0257	0.235	Contravidrio curvo interior 36mm		7
MT-0394	0.817	Caja de agua auxiliar		4
MT-0415	0.200	Tapa junta recto		4
MT-6517	0.532	Premarco		4
MT-6525	1.045	Marco Ventana escalonada		4
MT-6528	1.380	Hoja para puerta de rebatir		4
MT-6533	0.204	Contravidrio recto exterior de puerta		5
MT-6534	0.368	Contravidrio recto interior 40mm		5



Línea **Mass R60**

HOJA OCULTA

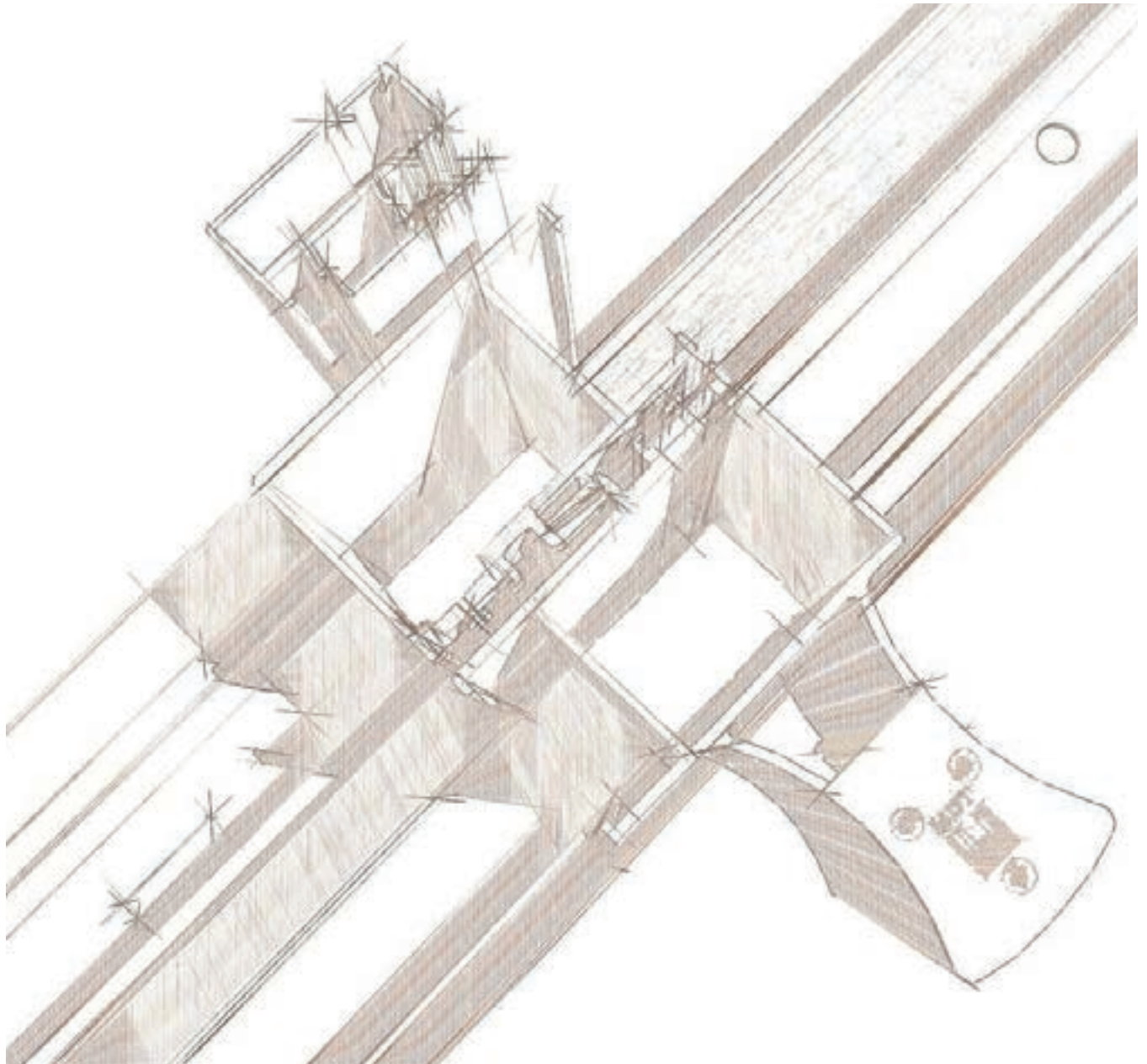

VENTANA DE ABRIR

HOJA OCULTA

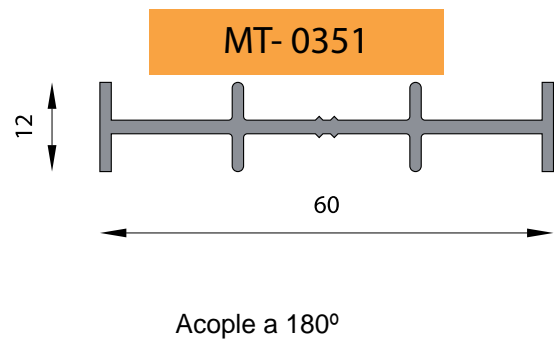
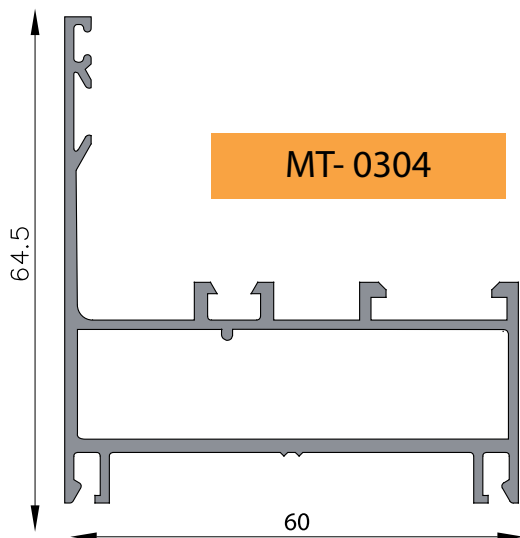
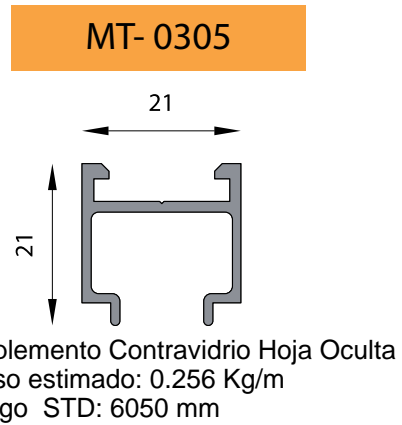
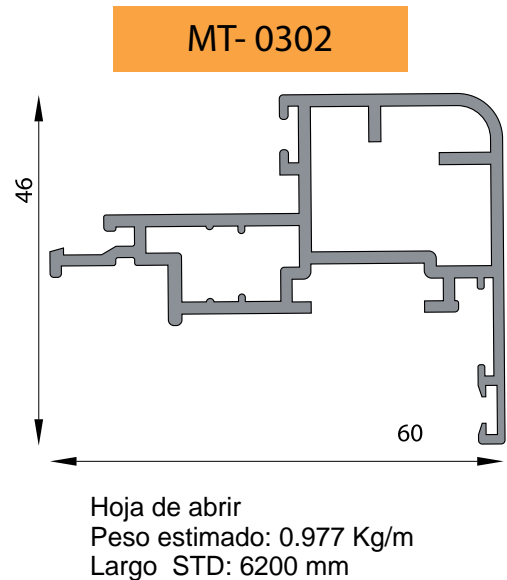
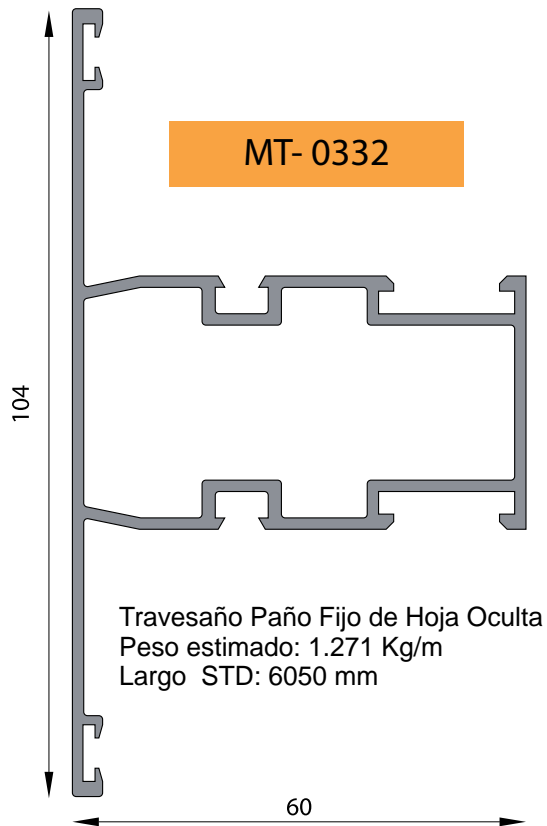

VENTANA DE ABRIR

HOJA OCULTA

MT- 0303

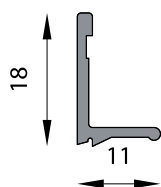

Contravidrio Hoja Oculta
Peso estimado: 0.108 Kg/m
Largo STD: 6050 mm

MT- 0342

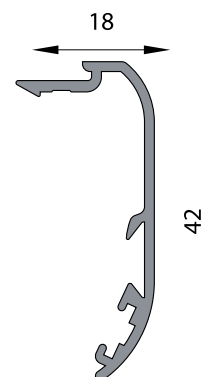

Contramarco
Peso estimado: 0.265 Kg/m
Largo STD: 6200 mm

MT- 0304

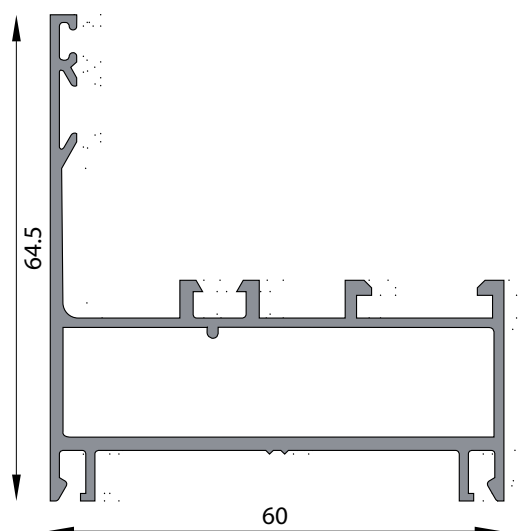

Marco hoja oculta - paño fijo
Peso estimado: 1.015Kg/m
Modificación no vigente

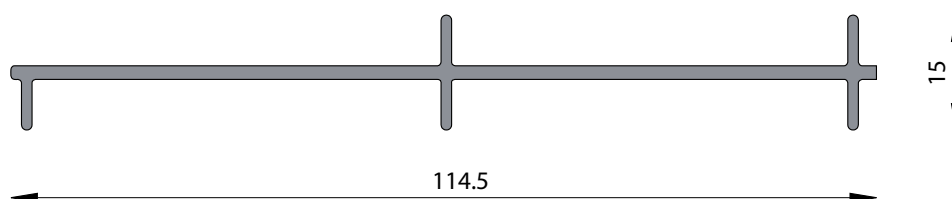

MT- 4026

Acople 60 mm a marco tres guías
Peso estimado: 0.224 Kg/m

BRD / COMPLEMENTARIOS / BARANDA

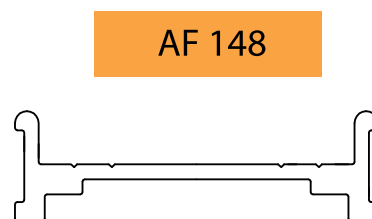
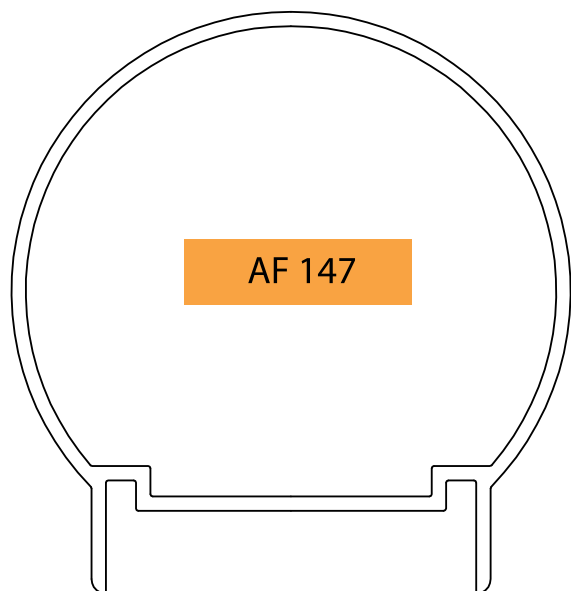

AF 185



AF 270

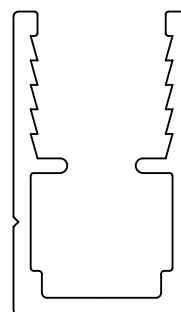

SOPORTES VIDRIO

AF 285



AF 269

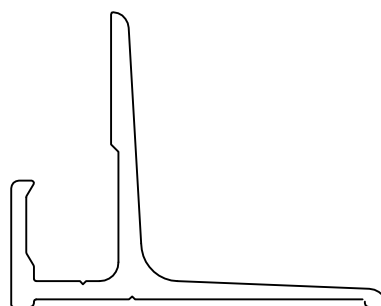

R 27A

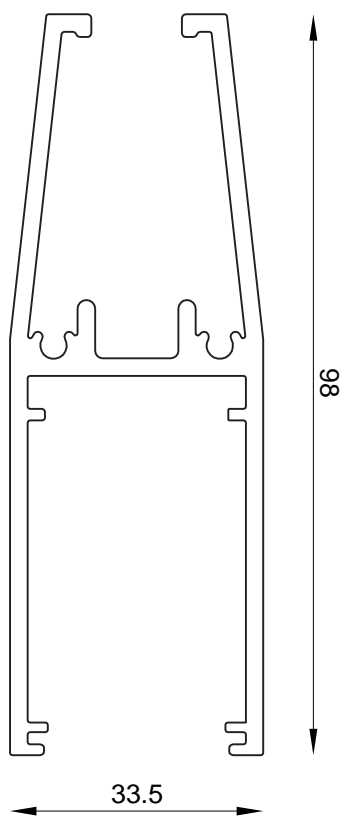

Para mas información ingresar a www.aluminiopanamericana.com.ar

DETALLE DE CONTRAVIDRIOS

MT- 0230

Contra Vidrio curvo interior 29 mm
 Peso estimado: 0.213 Kg/m
 Largo STD: 6030 mm

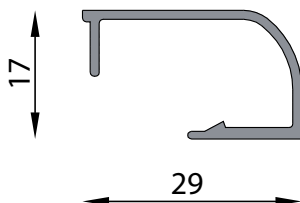

MT- 0231

Contra Vidrio curvo interior 15 mm
 Peso estimado: 0.159 Kg/m
 Largo STD: 6030 mm

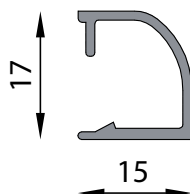

MT- 0232

Contra Vidrio curvo interior 22 mm
 Peso estimado: 0.181 Kg/m
 Largo STD: 6030 mm

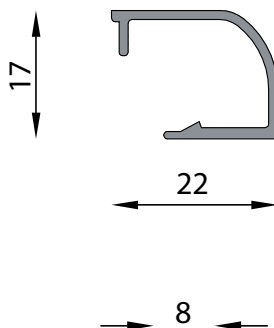

MT- 0233

Contra Vidrio curvo interior 8 mm
 Peso estimado: 0.135 Kg/m
 Largo STD: 6030 mm

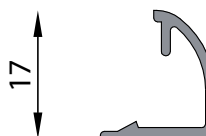





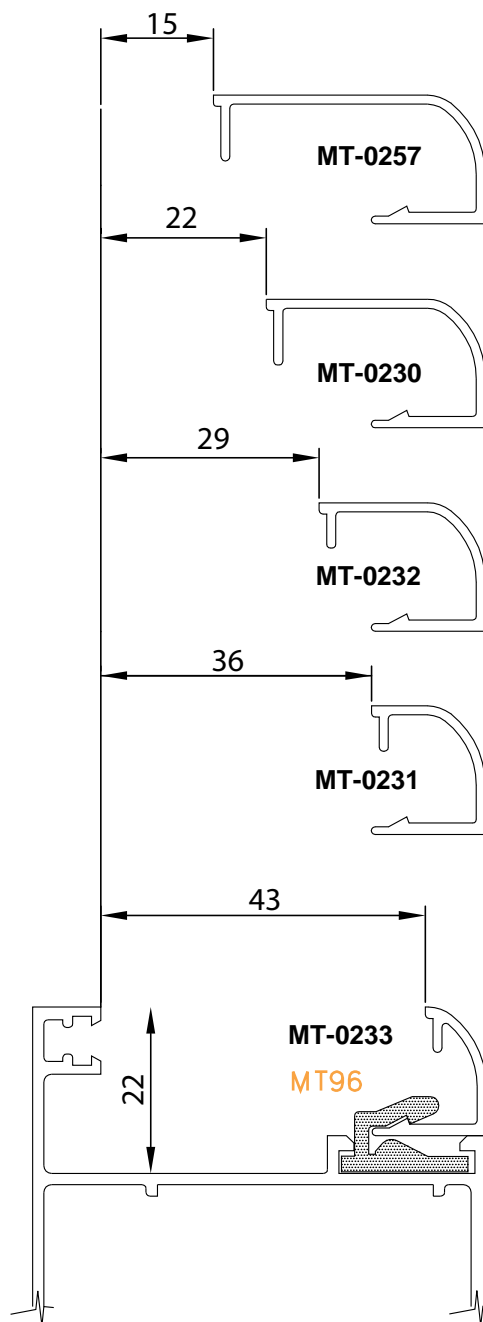
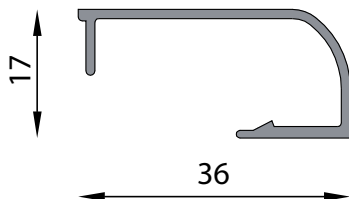







MT- 0257

Contra Vidrio curvo interior 36 mm
 Peso estimado: 0.235 Kg/m
 Largo STD: 6030 mm

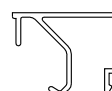
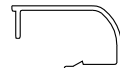
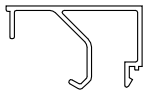
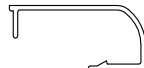

Atención: Colocar un clip de contra vidrio MT96 a 40mm de cada esquina y el resto a una distancia máxima de 200mm entre cada uno. En caso de necesitar retirar el contra vidrio cambiar los MT96, debido a que pierde su capacidad de sujeción. Todos los valores son orientativos y están sujetos a las propias tablas de los fabricantes de herrajes que garanticen su funcionalidad y durabilidad.

BURLETES Y CONTRAVIDRIOS PARA DETERMINAR EL ESPESOR DEL VIDRIO

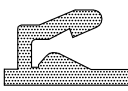
<p>MB 68 Burlete para acristalar </p>				
Burlete cuña 2 mm	Burlete cuña 3 mm	Burlete cuña 4 mm	Contra vidrios Rectos	Contra vidrios Curvos
MB 29 	MB 30 	MB 31 		
Espesores de vidrios (VS-DVH)				
38	37	36	 MT-0238	 MT-0233
31	30	29	 MT-0226  MT-6535	 MT-0231
24	23	22	 MT-0225	 MT-0232
17	16	15	 MT-0217	 MT-0230
10	9	8	 MT-0212	 MT-0257
6	5	4	 MT-6534	 MT96
Espesores de vidrios simples standard: 3 - 4 - 5 - 6 - 8 - 10 - 12 - 15 - 19 mm				
Espesores de cámaras standard para DVH: 6 - 9 - 12 - 15 - 20 - 27 mm				



Atención: Colocar un clip de contra vidrio MT96 a 40mm de cada esquina y el resto a una distancia máxima de 200mm entre cada uno. En caso de necesitar retirar el contra vidrio, reemplazar los MT96.

PERFILES ESTRUCTURALES

TUBOS REDONDOS

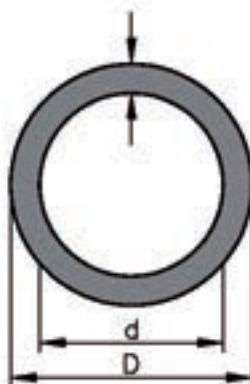

Perfil	Peso métrico	D [mm]	d [mm]	e [mm]
TR-246	0.132	9.5	5.3	2.1
TR-260	0.127	15.95	13.95	1
TR-241	0.408	19	13	3
TR-061	0.176	19.05	16.75	1.15
TR-013	0.224	19.05	16.05	1.5
TR-256	0.292	19.05	15.05	2
TR-208	0.213	22.2	19.8	1.2
TR-255	0.181	22.2	20.2	1
TR-257	0.208	22.2	19.9	1.15
TR-015	0.265	22.22	19.22	1.5
TR-261	0.248	22.22	19.42	1.4
TR-210	0.300	25	22	1.5
TR-258	0.268	25.4	23.1	1.15
TR-254	0.397	25.4	21.4	2
TR-213	0.570	25.4	19.4	3
TR-502	0.562	31.45	26.95	2.25
TR-017	0.413	34	31	1.5
TR-381	0.467	38.1	35.1	1.5
TR-020	0.783	38.1	32.9	2.6
TR-008	1.045	44	38	3
TR-021	1.680	48.3	39.38	4.47
TR-012	0.626	50.8	47.8	1.5
TR-227	0.896	54.8	50.6	2
TR-060	0.745	60	57	1.5
TR-209	1.526	63	57	3
TR-601	0.786	63.5	60.5	1.5
TR-005	0.872	70	67	1.5
TR-006	0.948	76	73	1.5
TR-212	1.256	76	72	2
TR-007	1.323	80	76	2
TR-004	1.112	89	86	1.5
TR-009	2.214	90	84	3
TR-251	1.233	101.4	98.5	1.45
TR-003	1.274	101.6	98.6	1.5
TR-031	1.523	101.6	98	1.8
TR-002	1.596	127	124	1.5
TR-001	2.174	152.4	149	1.7

● EN STOCK

TUBOS CUADRADOS

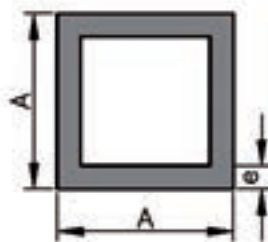

Perfil	Peso métrico	A [mm]	e [mm]
● TC-101	0.154	12.7	1.25
● TC-015	0.186	15	1.25
● TC-020	0.264	20	1.25
● TC-025	0.381	25	1.5
● TC-048	1.018	45	2.2
● TC-030	0.389	30	1.25
● TC-231	0.482	30	1.5
● TC-038	0.591	38	1.5
● TC-760	0.959	38	2.5
● TC-303	0.594	38.1	1.5
● TC-045	0.705	45	1.5
● TC-049	0.786	50	1.5
● TC-050	1.037	50	2
● TC-060	0.948	60	1.5
● TC-801	1.268	76	1.6
● TC-086	3.499	86	4

● EN STOCK

TUBOS RECTANGULARES

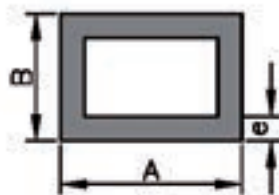

Perfil	Peso métrico	A [mm]	B [mm]	e [mm]
● TC-032	0.316	30	12	1.5
● TC-031	0.381	30	20	1.5
● TC-138	0.488	38	25	1.5
● TC-140	0.462	40	20	1.5
● TC-503	0.462	40	20	1.5
● TC-151	0.502	50	15	1.5
● TC-152	1.037	50	20	3
● TC-052	0.489	50	25	1.25
● TC-150	0.583	50	25	1.5
● TC-630	0.694	50	25	1.8
● TC-160	0.624	60	20	1.5
● TC-161	0.694	60	25	1.5
● TC-061	0.705	60	30	1.5
● TC-170	0.867	70	40	1.5
● TC-171	1.685	70	40	3
● TC-175	0.786	75	25	1.5
● TC-666	0.786	75	25	1.8
● TC-177	0.988	75	50	1.5
● TC-783	1.180	75	50	1.8
● TC-781	3.105	75	50	5
● TC-180	0.948	80	40	1.5
● TC-190	1.229	90	40	1.8
● TC-297	1.361	90	40	2
● TC-782	3.547	90	40	5.5
● TC-583	1.620	100	25	2.5
● TC-100	1.374	100	45	1.8
● TO-1036	1.158	101.6	44.5	1.5
● TC-115	1.739	115	50	2
● TC-125	1.847	125	50	2
● TC-153	2.633	150	50	2.5

● EN STOCK

PERFILES "L"

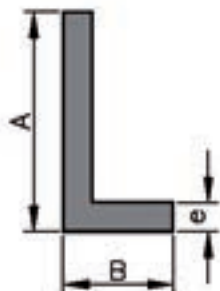

Perfil	Peso métrico	A [mm]	B [mm]	e [mm]
NL-867	0.124	19	12.7	1.5
NL-865	0.118	20	10	1.5
NL-852	0.197	25.4	12.7	2
NL-033	0.176	30	15	1.5
NL-863	0.232	30	15	2
NL-775	0.207	35	25	1.3
NL-037	0.248	38	25	1.5
NL-040	0.238	40	20	1.5
NL-869	0.394	50	25	2
NL-868	0.704	50	40	2
NL-856	0.302	50.8	25.4	1.5
NL-856	0.594	50.8	25.4	3
NL-851	0.470	50.8	38	2
NL-866	0.286	60	12	1.5
NL-080	0.529	80	20	2
NL-100	0.637	100	20	2
NL-862	0.799	100	50	2

● EN STOCK

PERFILES "T"

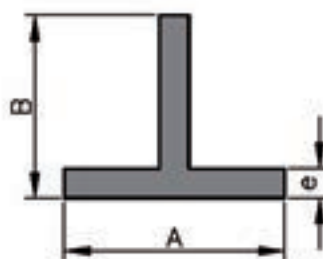

Perfil	Peso métrico	A [mm]	B [mm]	e [mm]
● NT-Ø14	0.127	12.7	12.7	2
● NT-Ø19	0.200	19	19	2
● NT-Ø25	0.136	25.4	25.4	1
● NT-Ø30	0.200	25.4	25.4	1.5
● NT-Ø34	0.259	25.4	25.4	2
● NT-Ø41	0.251	31.75	31.75	1.5
● NT-Ø47	0.302	38	38	1.5
● NT-Ø57	0.591	38	38	3
● NT-Ø70	0.537	50.8	50.8	2
● NT-Ø86	0.853	110	50.8	2

● EN STOCK

PERFILES "U"

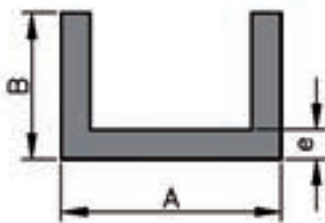

Perfil	Peso métrico	A [mm]	B [mm]	e [mm]
● NU-750	0.176	11	19	1.4
● NU-082	0.143	12.7	12.7	1.5
● NU-018	0.173	12.7	18	1.35
● NU-025	0.227	14.2	25	1.35
● NU-040	0.370	14.2	39	1.35
● NU-751	0.259	15	28	1.4
● NU-230	0.184	15.9	15.9	1.5
● NU-084	0.219	19	19	1.5
● NU-559	0.127	20	10	1.25
● NU-317	0.302	20	20	2
● NU-021	0.136	20.9	12	1.2
● NU-557	0.297	25.9	25.4	1.5
● NU-249	0.316	29	26	1.5
● NU-067	0.262	34	17	1.5
● NU-340	0.324	60	11.5	1.5
● NU-558	0.559	101	20	1.5

● EN STOCK

PLANCHUELAS

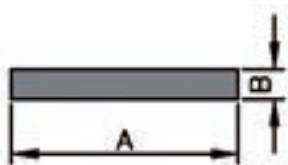

Perfil	Peso métrico	A [mm]	B [mm]
NP-501	0.103	12.7	3
NP-503	0.173	12.7	5
NP-504	0.070	13	2
NP-505	0.086	15.9	2
NP-506	0.130	15.9	3
NP-507	0.172	15.9	4
NP-510	0.103	19	2
NP-511	0.154	19	3
NP-512	0.205	19	4
NP-513	0.257	19	5
NP-514	0.243	19	5 cr
NP-516	0.120	22.2	2
NP-026	0.100	25	1.5
NP-025	0.138	25.4	2
NP-520	0.206	25.4	3
NP-521	0.275	25.4	4
NP-522	0.343	25.4	5
NP-523	0.435	25.4	6.35
NP-524	0.688	25.4	10
NP-030	0.202	30	2.5
NP-529	0.343	31.75	4
NP-530	0.430	31.75	5

Perfil	Peso métrico	A [mm]	B [mm]
NP-531	0.529	31.75	6
NP-032	0.173	32	2
NP-033	0.259	32	3
NP-038	0.205	38.1	2
NP-039	0.308	38.1	3
NP-537	0.410	38.1	4
NP-539	0.619	38.1	6
NP-540	1.029	38.1	10
NP-045	0.302	45	2.5
NP-051	0.297	50	2.2
NP-052	0.406	50	3
NP-546	0.410	50.8	3
NP-547	0.548	50.8	4
NP-548	0.654	50.8	4.76
NP-550	1.372	50.8	10
NP-552	2.743	50.8	20
NP-567	0.324	60	2
NP-060	1.620	60	10
NP-061	3.237	60	20
NP-562	2.151	79.4	10
NP-614	0.432	80	2
NP-565	2.737	101	10
NP-566	3.496	101.6	12.7

● EN STOCK

ANGULOS

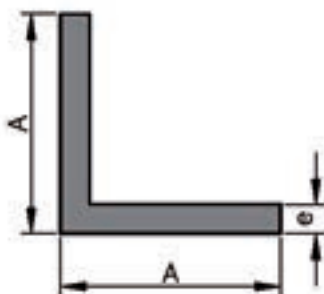

Perfil	Peso métrico	A [mm]	e [mm]
NL-800	0.092	9.5	2
NL-012	0.103	12	1.5
NL-015	0.118	15	1.5
NL-806	0.149	19	1.5
NL-020	0.165	20	1.6
NL-809	0.205	20	2
NL-027	0.381	25	3
NL-025	0.135	25.4	1
NL-026	0.162	25.4	1.2
NL-811	0.266	25.4	2
NL-812	0.386	25.4	3
NL-831	0.261	31.75	1.5
NL-032	0.254	32	1.5
NL-814	0.335	32	2
NL-039	0.400	38	2
NL-820	0.591	38	3
NL-036	0.778	38	4
NL-051	0.400	50	1.5
NL-050	0.786	50	3
NL-829	0.405	50.8	1.5
NL-823	0.537	50.8	2
NL-824	0.799	50.8	3
NL-830	1.053	50.8	4
NL-826	1.304	50.8	5

● EN STOCK

Líneas de Contacto

📞 11-5023-7969

📘 Aluminio Panamericana

📷 Aluminio.Panamericana.ok

📞 4756+5834 / 4762-3487 / 4554-2838

✉️ ventas@aluminiopanamericana.com.ar

📍 Colectora Este 1717, Don Torcuato

